



Quasar

PLAIN • PAPER • FAX

Model No. **PPX2000**



Operating Instructions

FOR ASSISTANCE, CALL 1-800-HELP-FAX

Please read these Operating Instructions before using the unit.

*Thank you for purchasing the Quasar Plain Paper Facsimile.
Before using the unit, please read these Operating Instructions completely.
You can then easily install, configure and operate the unit properly.*

WARNING: Do not remove covers and do not repair yourself.
Refer servicing to qualified personnel.

When you operate this product, the socket outlet should be near the product and be easily accessible.

To prevent fire or shock hazard, do not expose this product to rain or any type of moisture.

CAUTION: If ingestion of toner occurs, drink several glasses of water to dilute stomach contents, and seek immediate medical treatment. If eye contact with toner occurs, flush thoroughly with water, and seek medical treatment. If skin contact with toner occurs, wash thoroughly with soap and water.

Important Phone Numbers ***For United States Only***

Authorized Service Center:	1-800-545-2672
Accessory Purchases:	1-800-332-5368
Technical Support:	1-800-HELP-FAX

(See page 189 for details.)

The serial number of the unit may be found on the label on the rear of the unit. For your convenience, note this number below, and retain this book along with your proof of purchase, to serve as a permanent record of your purchase in the event of a theft, or for future reference.

Model No. _____

Name of dealer _____

Address of dealer _____

Serial No. _____
(found on the rear of the unit)

Date of purchase _____

IMPORTANT:

The Telephone Consumer Protection Act of 1991 makes it unlawful for any person to use a computer or other electronic device to send any message via a telephone facsimile machine unless such a message clearly contains in a margin on the top or bottom of, at least, the first sent page the following information:

- 1) Date and time of transmission; and,
- 2) Identification of either business, business entity or individual sending the message; and,
- 3) Telephone number of either the sending machine, business, business entity or individual.

In order to program this information into your facsimile machine, you must complete the steps on pages 33 to 40 in these Operating Instructions.

Any details given in these instructions are subject to change without notice.

The photograph on the cover page may vary slightly from the actual product.

Chapter 1 *Installation and Initial Preparation*

1

Chapter 2 *Basic Instructions*

2

Chapter 3 *Advanced Instructions*

3

Chapter 4 *Registration*

4

Chapter 5 *Troubleshooting and Maintenance*

5

Chapter 6 *General Information*

6

Table of Contents

	Page
<i>Before Using</i>	
Features	7
Receiving Modes and HELP Function	8
Enclosures	9
Precaution	10
Location of Controls	11
Buttons and Indicators	12
<i>Chapter 1 — Installation and Initial Preparation</i>	
Installing the Unit	16
Installation connections	16
Preparing the toner cartridge	17
Installing the drum unit	19
Installing the receiving tray	21
Installing the document feeder tray	22
Installing the paper cassette and loading paper	22
Turning the power switch on	25
Setting selectors	26
Display Indication	27
Selecting the Receiving Mode	28
Selecting the Paper Size	29
System Programming Features	30
Basic features	30
Advanced features	31
Setting date and time	33
Setting your logo and facsimile telephone number	34
How to use the character keys	37
<i>Chapter 2 — Basic Instructions</i>	
<i>Facsimile</i>	
Transmitting Documents	42
Before transmitting documents	42
Manual transmission (Case 1)	45
Redialing the last dialed number	46
Manual transmission (Case 2)	47
Receiving Documents	48
Manual reception	48
Automatic reception	49
Receiving over-sized documents	51
Memory reception	52
<i>Copier</i>	
Making Copies	53
<i>Telephone</i>	
Making and Answering Voice Calls	54
Making voice calls	54
Redialing the last dialed number	56
Answering voice calls	56

Chapter 3 — Advanced Instructions

Storing Phone Numbers for Automatic Dialer	58
Filling in the directory card	58
Storing phone numbers for one-touch dialing	59
Storing multistations for one-touch dialing	61
Storing phone numbers for speed dialing	63
Storing secret phone numbers	65
Erasing Stored Phone Numbers	67
Printing Stored Phone Number List	70
Printing the telephone number list	71
Electronic Telephone Directory	72
Before using the electronic telephone directory	72
How to use the electronic telephone directory	73
<i>Facsimile</i>	
Transmitting Documents Using Automatic Dialer	75
Using one-touch dialing	75
Using the broadcast keys	76
Using speed dialing	77
Using the electronic telephone directory	78
Reserving Transmission while Receiving Documents	80
Delayed Transmission	81
Polling	85
Polling another machine	85
Being polled	86
Programming the polling passcode	88
Multistation Transmission	90
Multitransmission report	92
Memory Transmission	93
Setting the memory transmission	93
Transmitting the stored documents	94
Network Communication	96
Using the network passcode	96
Programming the network passcode	98
Turning on the transmission passcode check mode	99
Turning on the reception passcode check mode	100
Forwarding Received Documents	101
Fax forwarding report	103
Retrieving mis-forwarded documents	104
Turning on or off the forwarding feature from a remote location	104
Using the TRANSMIT SETTING Button	106
Total page number and the special message	106
Overseas transmission mode	107
Transmitting documents with the TRANSMIT SETTING button	107
Programming a personal message	109
<i>Telephone</i>	
Making Voice Calls Using Automatic Dialer	111
Making voice calls using the electronic telephone directory	112
Voice Contact	113
Initiating voice contact	113
Receiving a request for voice contact	114
TONE, FLASH, PAUSE, and MUTE Buttons	115
Changing from pulse to tone mode (TONE button)	115
Accessing features of your host exchange (FLASH button)	115
Inserting a pause into a phone number (PAUSE button)	116
Voice muting (HANDSET MUTE button)	117

<i>Reserve Phone</i>	
Reserve Phone	118
<i>Chapter 4 — Registration</i>	
Setting the Individual Transmission Report Printing	120
Selecting the Number of Rings in the FAX Mode	122
Setting the Logo Print Position	123
Setting the Journal Report Printing	124
Setting the automatic journal report printing	125
Printing the journal report manually	126
Selecting the Number of Fax Recognition Rings	127
Setting the Copy Mode	128
Setting the reduction or inhibition mode	128
Making extension copies	130
Setting the Receiving Reduction Mode	132
Additional Feature for Distinctive Ring Service	134
Programming your unit with distinctive ringing pattern	134
Adjusting the Display Contrast	136
Selecting the Number of Rings of Reserve Phone	137
Setting the Transmission Speed	139
Setting the Message Alert	140
Resetting the System Programming Features	141
Printing the System Programming List	143
<i>Chapter 5 — Troubleshooting and Maintenance</i>	
Troubleshooting	146
Error display messages	146
Explanation of communication result on the report	149
General corrective measures	150
Clearing a document jam	153
Adjusting the feed pressure	154
Clearing a recording paper jam	155
If a Power Failure Occurs...	159
Power-down report	159
Maintenance	160
Cleaning the cabinet	160
Cleaning the document feeder unit	160
Cleaning the printer	162
Replacing the cleaning pad and the toner cartridge	163
Replacing the drum unit	169
Repacking	172
<i>Chapter 6 — General Information</i>	
Accessory Order Information	180
Specifications	181
Main unit specifications	181
Paper specifications	182
Speed Dial Directory	183
Index	185
FCC Information	188
Servicenter Directory	189
Limited Warranty	190

Features

Multi-function system by using one telephone line

General

- Compact, vertical design
- Help function (page 8)
- LCD (Liquid Crystal Display) readout (page 27)
- Automatic voice/facsimile switching (page 49)

Plain Paper Facsimile Machine

- 15 second transmission speed*
- Letter/Legal, G3 compatible
- Automatic document feeder
- 30 station one-touch dialer (page 59)
- 100 station speed dialer (page 63)
- 5 broadcast keys for multistation transmission (page 61)
- Resolution: Standard/Fine/Halftone (32 level) (page 43)
- Contrast: Normal/Light/Darker (page 43)
- Delayed transmission (page 81)
- Polling function (page 85)
- Multistation transmission (page 90)
- Silent ring fax recognition system (page 127)
- Network passcode communication** (page 96)
- Passcode polling** (page 88)
- Fax forwarding function (page 101)
- Customized header (page 106)
- Overseas transmission function (page 107)

* Transmission times apply to text data by using ITU-TS No. 1 test chart, between the same models at maximum modem speed and may vary in actual usage.

**These functions are effective between other compatible facsimile machines that have the same passcode.

Quasar-compatible facsimile machines are:
e.g. PAX400, PAX600, PAX410

Large Memory***

- 20 page memory reception (page 52)
- 15 page memory transmission (page 93)
- 15 page memory forwarding reception (page 101)

***Memory capacity applies to text data by using ITU-TS No. 1 test chart in standard resolution.

Integrated Telephone System

- Electronic telephone directory (page 72)
- On-hook dialing (page 54)
- Voice muting (page 117)
- Redialing function (page 56)
- Temporary tone dialing (page 115)

Copier Function

- Extension copy (page 130)
- Multicopier function (page 53)

Receiving Modes and HELP Function

Receiving modes

This unit provides the following types of receiving modes. Depending on your situation, select the desired mode.

TEL/FAX (Telephone/Facsimile) mode:

When you are in the office, and you wish to use the unit as a standard telephone and a facsimile machine, select this mode.

The unit will automatically receive a document when a fax call comes in.

You can use the unit as a standard telephone when you answer a call during ringing.

FAX (Facsimile) mode:

When you wish to use the unit as a facsimile machine only, select this mode.

When a fax call comes in, the unit will automatically receive a document.

When a voice call comes in, the unit will emit a fax tone to the calling party, and you cannot talk to the other party.

TEL (Telephone) mode:

When you wish to use the unit as a standard telephone, select this mode.

If you receive a fax call, you will be able to receive a document manually. Automatic fax reception is not available.

For further details, see page 28.

NOTES:

- Making calls and transmitting documents are possible in every receiving mode.
- If you connect a telephone(s) on the same line to which your facsimile unit is connected, see page 118.

HELP function

The unit is equipped with the HELP function. Use this function if you lose your instructions while using the unit. It will provide you with instructions.

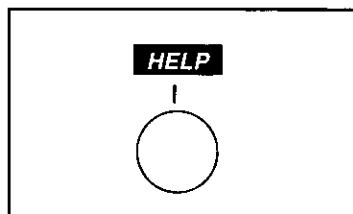

If you press **HELP**:

- While programming, the unit will print the relevant programming instructions.
- In idle status, the unit will print information on how to transmit a document, how to program the function, and how to store a phone number, etc.

Enclosures

After removing the unit from the packing carton, examine the unit for signs of shipping damage and check to make sure that all of the enclosures are included.

Telephone Line Cord 1 pc.

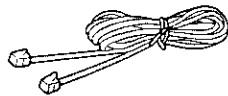

(Page 16)

Handset 1 pc.

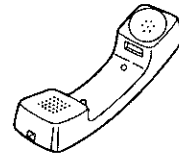

(Page 16)

Power Cord 1 pc.



(Page 16)

Handset Cord 1 pc.

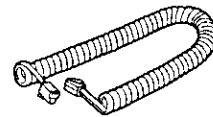

(Page 16)

Receiving Tray 1 pc.

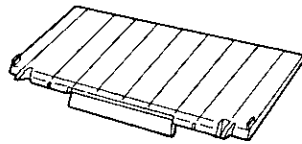

(Page 21)

Document Feeder Tray 1 pc.

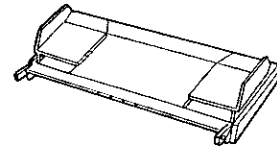

(Page 22)

Extenders 2 pcs.

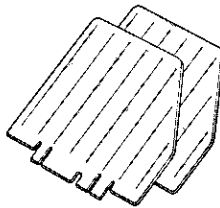

(Pages 21 and 22)

Paper Cassette 1 pc.

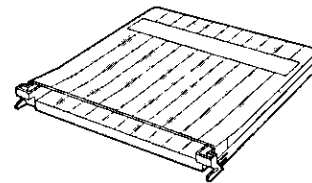

(Page 22)

Drum Unit 1 pc.

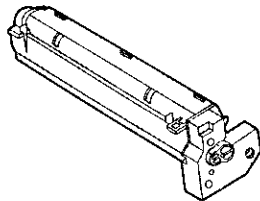

(Page 19)

Storage Bag 1 set
(Shipping cover bag and sealing tape)



(Pages 17 to 21)

NOTES:

- If you are missing any item, consult place of purchase.
- Save the original carton and packing materials for proper shipping and transporting of the unit.
- The toner cartridge is installed in the unit when shipped (see page 17).

Precaution

Installation

The unit should be placed on a sturdy and level surface.

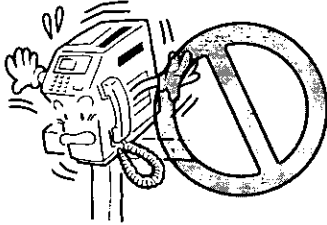

Keep the unit away from heating appliances, such as radiators or air conditioning units.

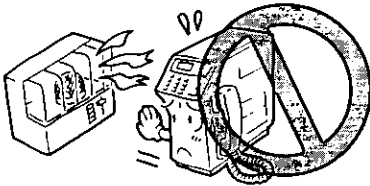

Keep the unit away from electrical noise-generating devices, such as fluorescent lamps and motors.

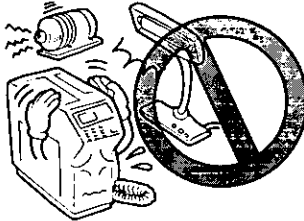

The unit should be kept free from dust, moisture, high temperature, and vibration.

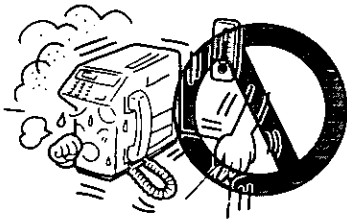

The unit should not be exposed to direct sunlight.

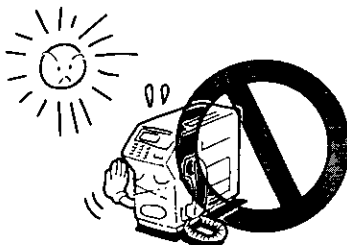

Handling

Do not allow any foreign matter to enter the interior of the unit, especially metal objects.

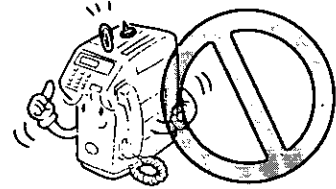

Do not place any covering over the unit while it is turned on.

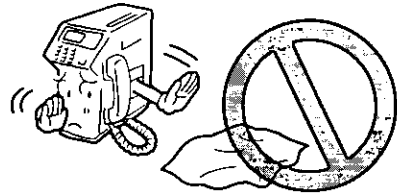

Do not damage the power cord.
Do not touch the plug with wet hands.

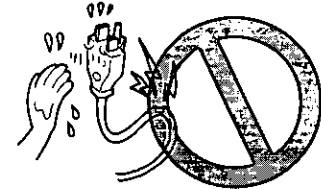

Keep the unit dry. Never operate the unit if liquid has been spilled into it. Immediately unplug the unit, have it inspected by a service technician. Fire and shock hazards can result from electrical shorts caused by liquid contact inside.



In order to avoid a paper jam, do not open the printer cover while in operation.

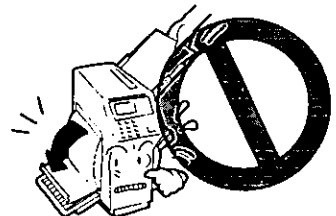

Location of Controls

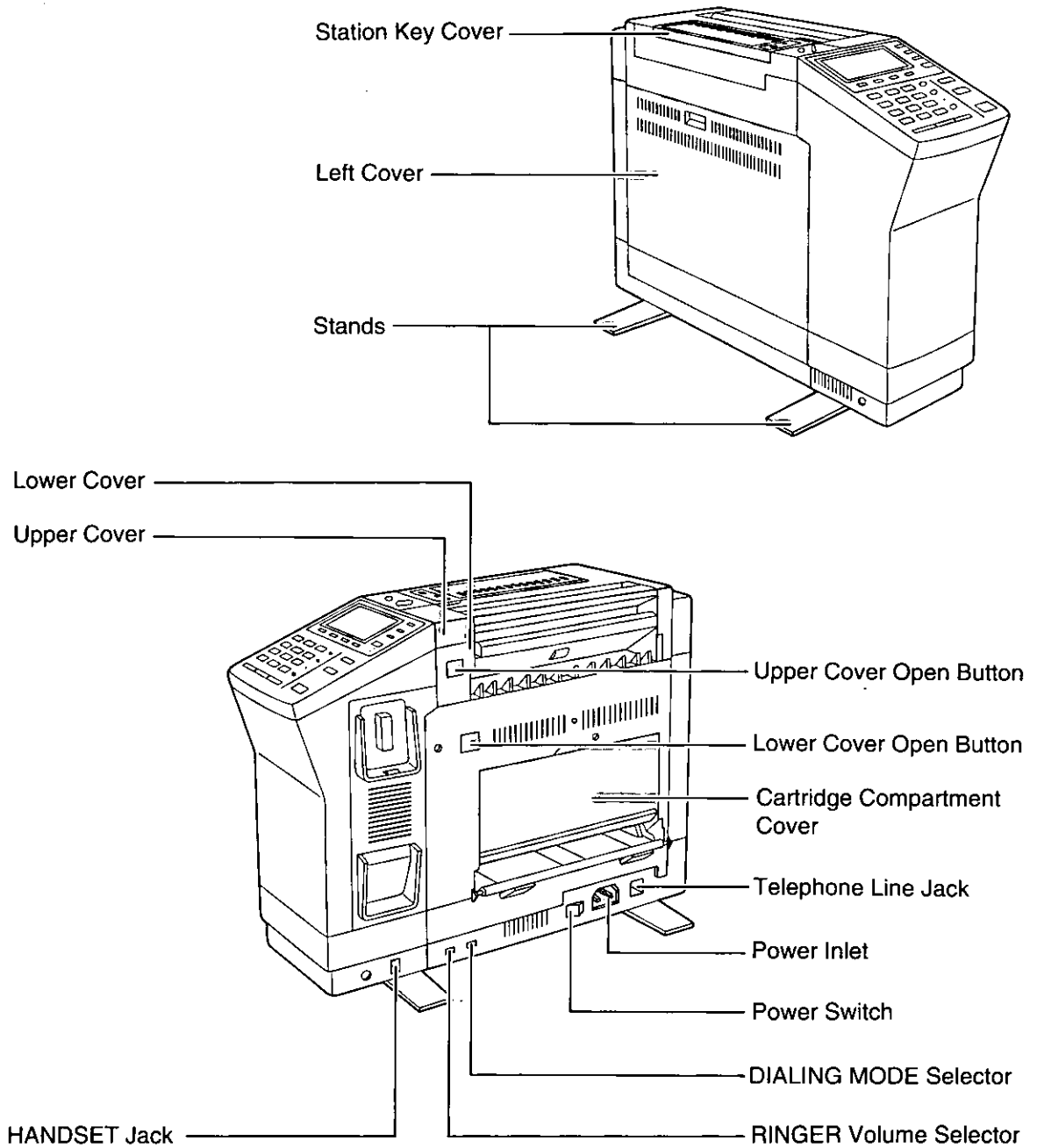

NOTE:

- To prevent the unit from falling down, lift the unit slightly and turn the stands to pull out.

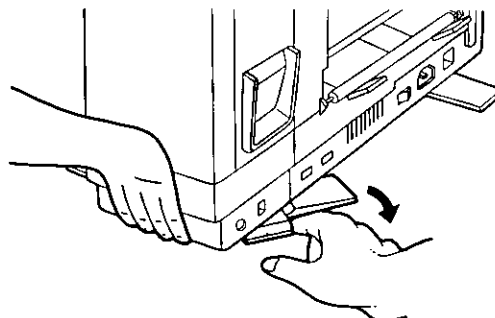

VOLUME Control Button
(Page 55)
Used to adjust the speaker or handset volume level.

HELP Button (Page 8)
Used to print easy guides of instructions.

TONE Button (Page 115)
Used to change the dialing mode from pulse to tone during a dialing operation.

FLASH Button
(Page 115)
Used to access features of your host private branch exchange.

REDIAL Button (Pages 46 and 56)
Used to redial the last dialed number.

MONITOR/VOICE STDBY Button and Indicator (Pages 45 and 113)
Used for on-hook dialing and voice contact functions.

Dial Keypad/Character Keys
Used to dial phone numbers or enter parameters while programming.
Also used to enter characters while programming.

AUTO DIAL Button
(Pages 63 and 77)
Used for speed dialing.

STOP/CLEAR Button
(Page 46)
Used to cancel transmission or copy operation.
Also used to clear the previously entered parameters while programming.

PAUSE Button
(Page 116)
Used to insert a pause into a phone number.

COPY Button (Page 53)
Used to start copy function.

START Button and Indicator
(Pages 45 and 48)
Used to start transmission or reception, or to print lists and reports.

HANDSET MUTE Button and Indicator
(Page 117)
Used when you do not wish your voice to be heard by the other party.

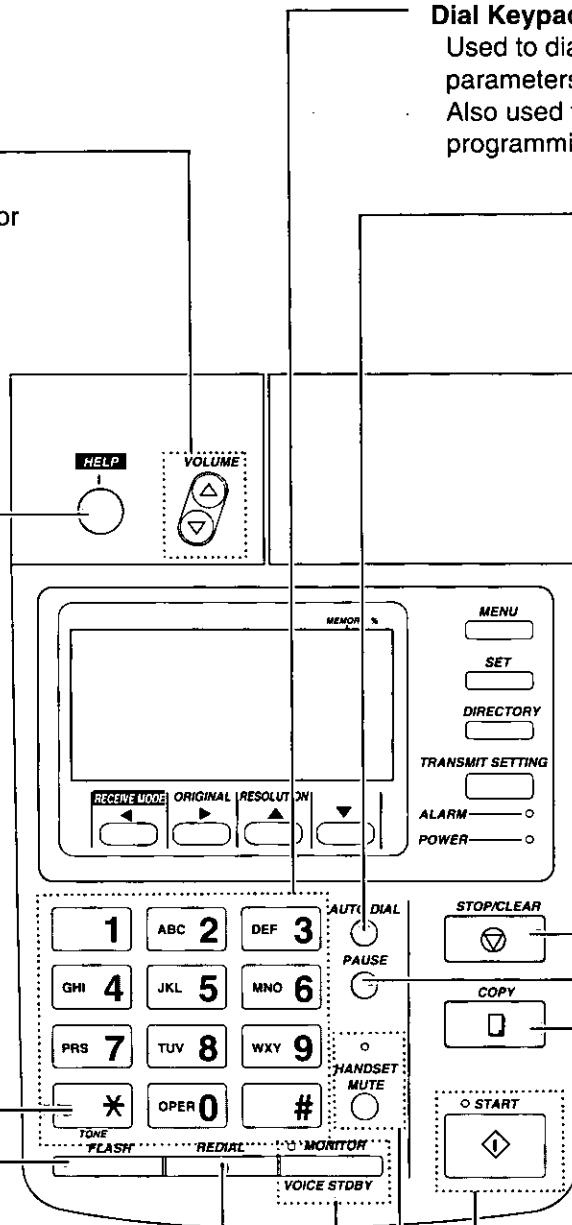

▼ Key (Page 73)

Used as the cursor key while programming.

RESOLUTION Button/▲ Key

(Pages 43 and 73)

Used to select the scanning line density. The display shows the mode in which the unit is set.

Also used as the cursor key while programming.

Liquid Crystal Display

(Page 27)

Provides convenient information.

RECEIVE MODE Button/◀ Key

(Pages 28 and 39)

Used to select the desired receiving mode. The display shows the mode in which the unit is set.

Also used as the cursor key while programming.

ORIGINAL Button/▶ Key

(Pages 39 and 43)

Used to select the desired contrast mode to transmit or make copies. The display shows the mode in which the unit is set.

Also used as the cursor key while programming.

TRANSMIT SETTING Button

(Page 106)

Used to start the transmission setting before transmission.

MENU Button

Used to start the various programming.

SET Button

Used to store parameters while programming.

DIRECTORY Button

(Page 73)

Used to dial phone numbers by using the electronic telephone directory.

ALARM Indicator

(Page 150)

The indicator light is on when trouble occurs.

POWER Indicator

The indicator light is on when the power is on.

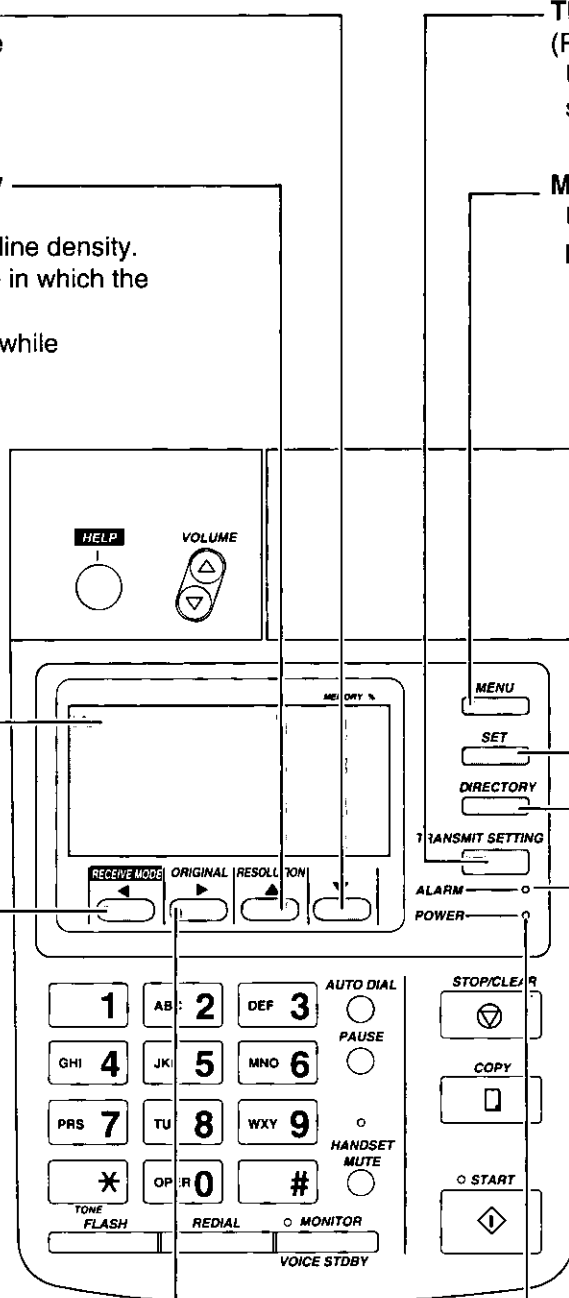

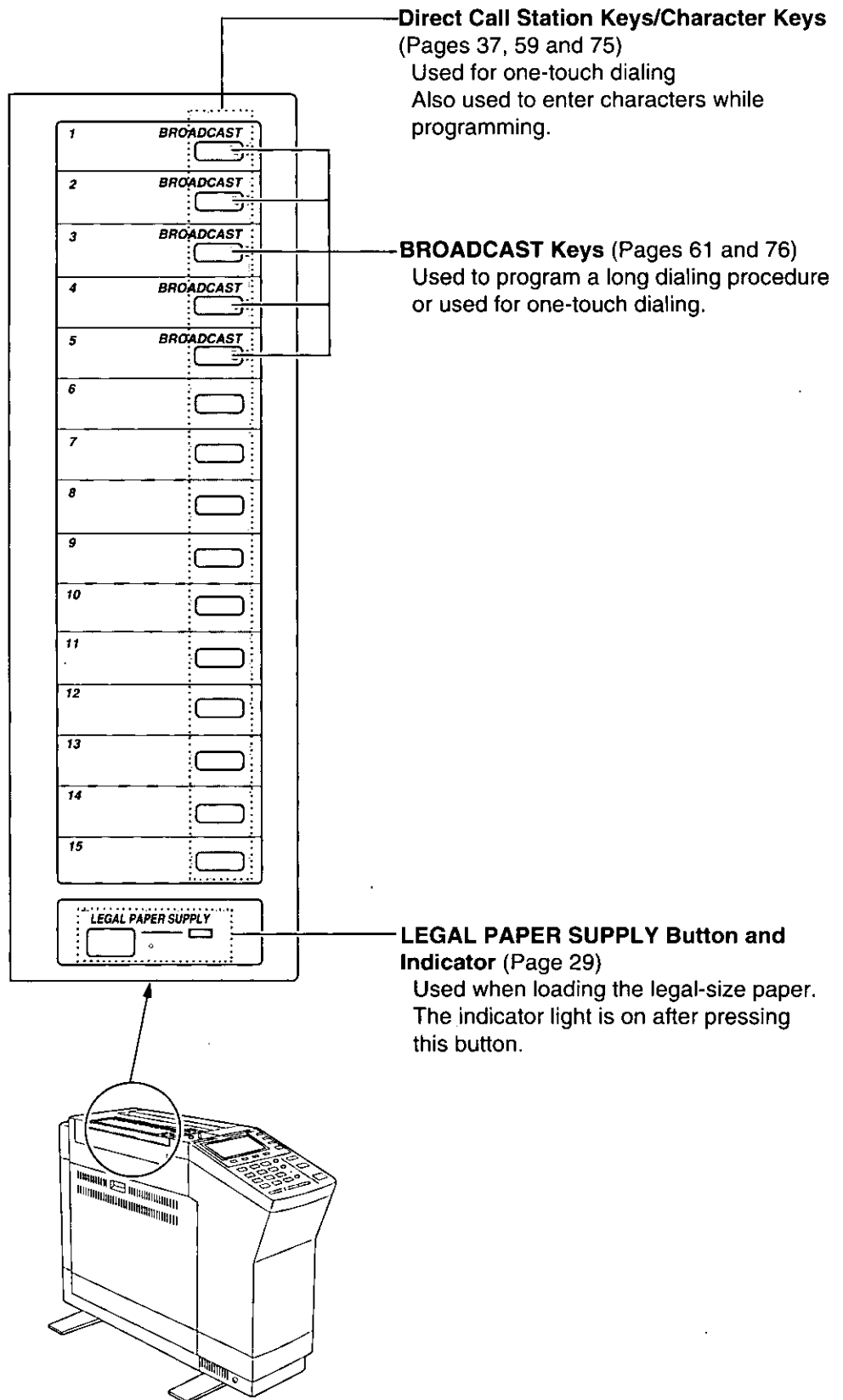

Chapter 1

Installation and Initial Preparation

Contents

	Page
Installing the Unit	16
Installation connections	16
Preparing the toner cartridge	17
Installing the drum unit	19
Installing the receiving tray	21
Installing the document feeder tray	22
Installing the paper cassette and loading paper	22
Turning the power switch on	25
Setting selectors	26
Display Indication	27
Selecting the Receiving Mode	28
Selecting the Paper Size	29
System Programming Features	30
Basic features	30
Advanced features	31
Setting date and time	33
Setting your logo and facsimile telephone number	34
How to use the character keys	37

Installing the Unit

Installation connections

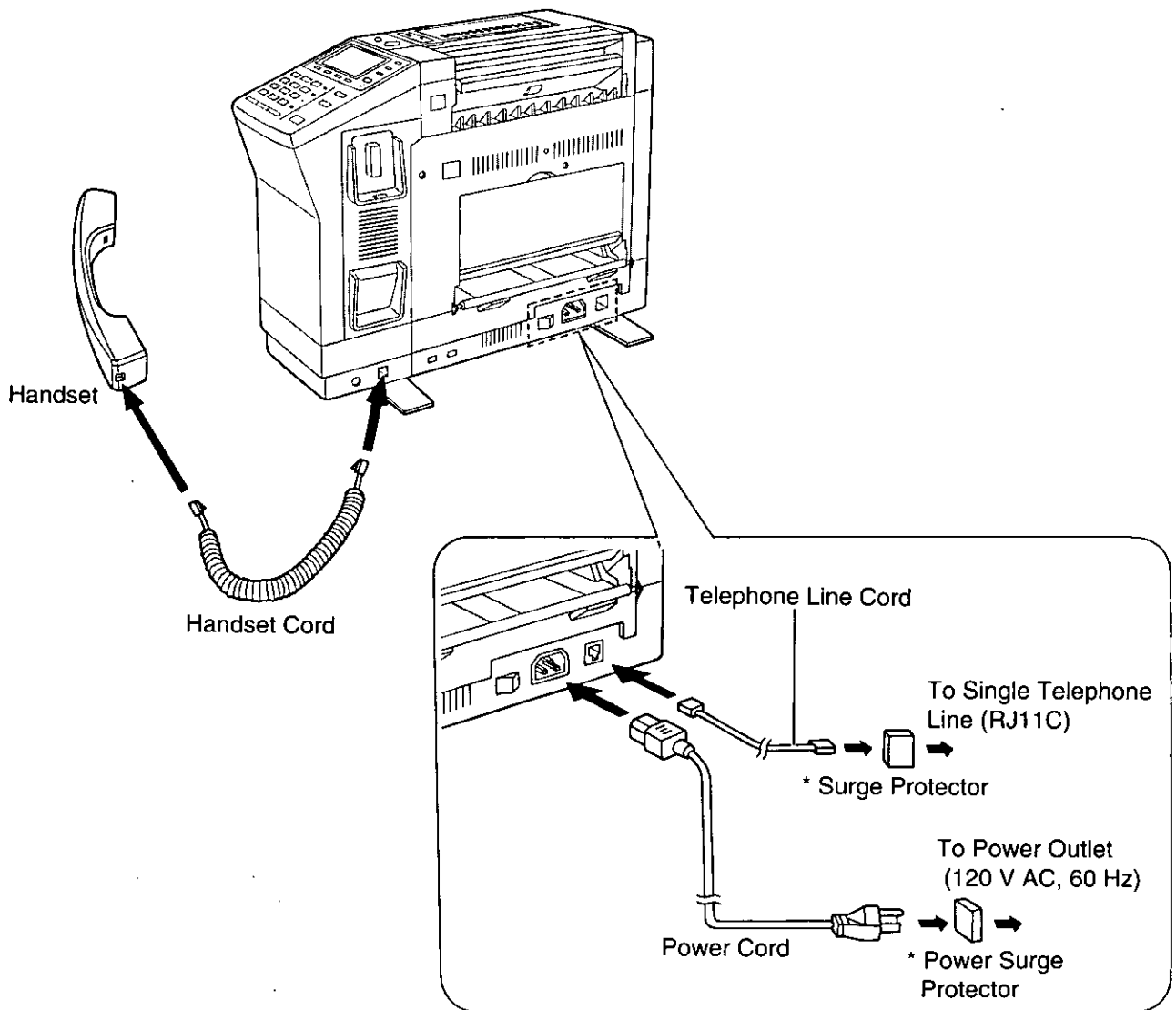

NOTES:

- The unit will not function during a power failure or when the power is turned off.
- Connection to integrated answering machines is not recommended.
- The unit is equipped with a 3-wire grounded-type plug for safety. If you are unable to insert the plug into an outlet, contact an electrician to replace the outlet.
- We recommend the use of an exclusive power outlet to avoid interference from other equipment.
- For additional equipment protection, we recommend the use of a surge protector, such as TELESPIKE BLOK MODEL TSB (TRIPPE MFG. CO.), SPIKE BLOK MODEL SK6-0 (TRIPPE MFG. CO.), SUPER MAX (PANAMAX), or MP1 (ITW LINX).

Minimum space requirements

The following minimum space requirements allow for the best performance.

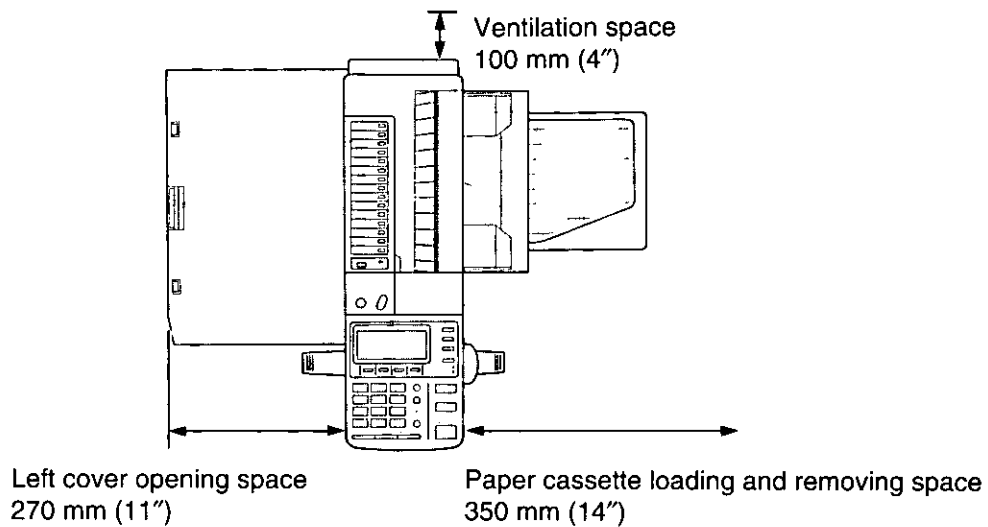

Preparing the toner cartridge

CAUTION:

- If ingestion of toner occurs, drink several glasses of water to dilute stomach contents, and seek immediate medical treatment. If eye contact with toner occurs, flush thoroughly with water, and seek medical treatment.
- If skin contact with toner occurs, wash thoroughly with soap and water.

1

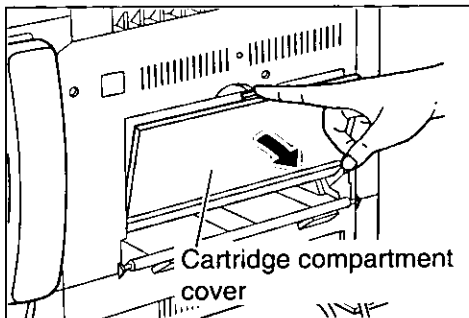

Open the cartridge compartment cover.

2

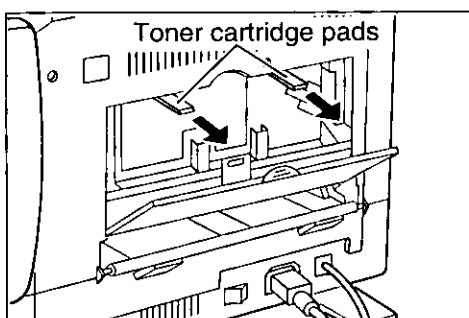

Remove the toner cartridge pads by pulling them outward.

NOTE:

- Place the toner cartridge pads in the storage bag and keep them in the event that the unit must be repacked and transported (see page 174).

(continued)

3

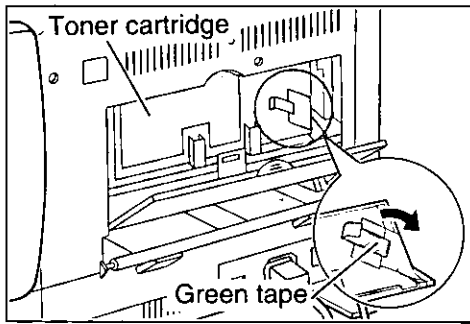

Peel off the green tape.

4

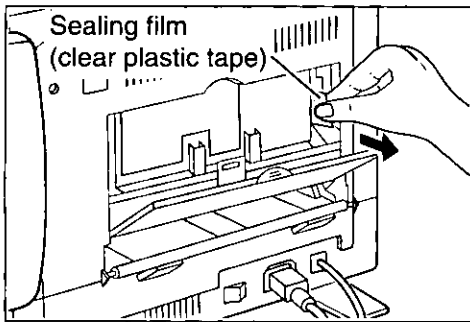

Hold the unit firmly, and completely remove the clear plastic sealing film by grasping it and pulling it outward.

NOTES:

- Do not twist the sealing film while pulling it, because toner may spill over.
- Be careful not to make the surrounding dirty when handling the sealing film, because it may contain toner residue.

5

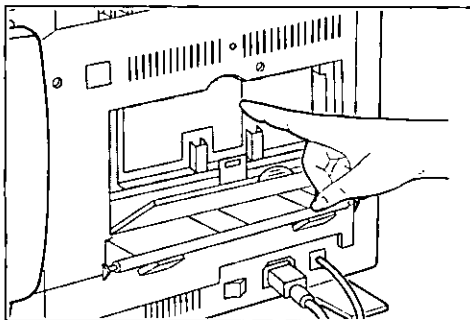

Tap the toner cartridge lightly to empty toner into the developer unit.

6

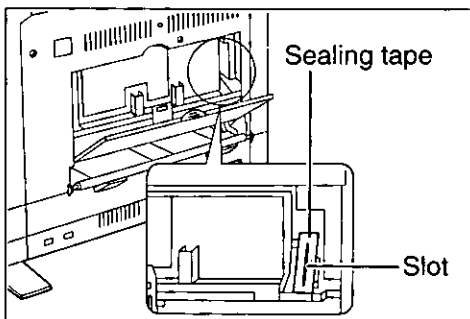

Remove the paper backing of the sealing tape provided, and press this tape over the slot on the rear side of the toner cartridge.

7

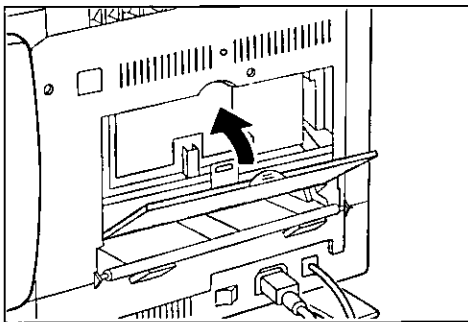

Close the cartridge compartment cover.

1

Installing the drum unit

CAUTION:

Do not open the protective bag until you have read the following instructions and are ready to install the drum unit. The drum unit contains a photosensitive drum. Exposing it to light may damage the drum.

Once you have opened the protective bag;

- Do not expose the drum unit to light for more than 5 minutes.
- Do not touch the green drum surface.
- Do not keep the drum unit near dust or dirt.
- Do not place the drum unit in a high humidity area.
- Do not expose the drum unit to direct sunlight.

1

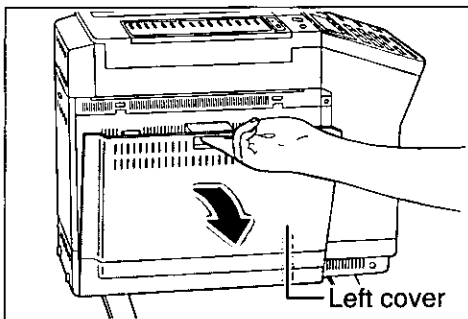

Open the left cover.

2

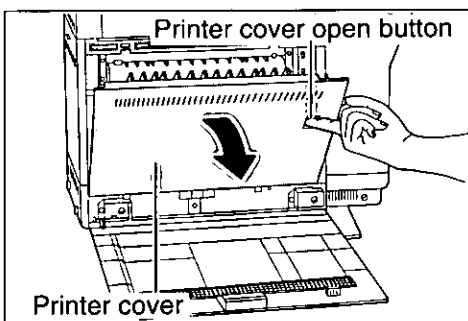

Open the printer cover by pulling the printer cover open button.

3

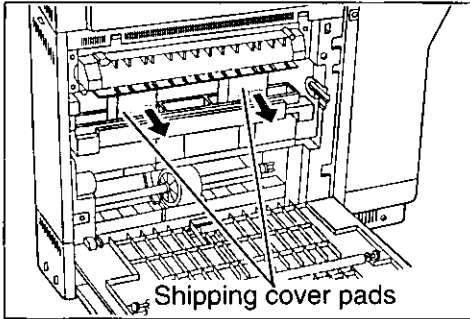

Remove the shipping cover pads by pulling them outward.

4

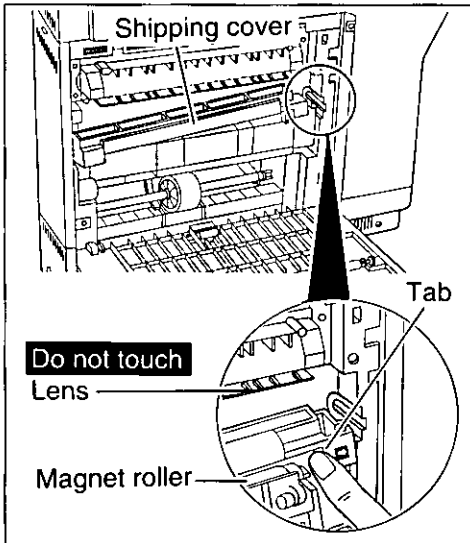

Press the tab of the shipping cover firmly toward the front, and lift the rear side of the shipping cover up and remove it by pulling it outward.

CAUTION:

– Do not touch the lens and magnet roller.

NOTE:

– Place the shipping cover in the shipping cover bag to ensure toner residue does not spill. Place this bag and the shipping pads in the storage bag and keep them in the event that the unit must be repacked and transported (see page 176).

5

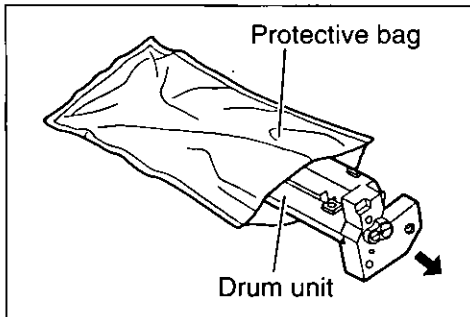

Open the protective bag by cutting the end of the bag and remove the drum unit.

NOTES:

– Do not expose the drum unit to light for more than 5 minutes as it may damage the drum unit.
 – Place the protective bag in the storage bag and keep it in the event that the unit must be repacked and transported (see page 176).

6

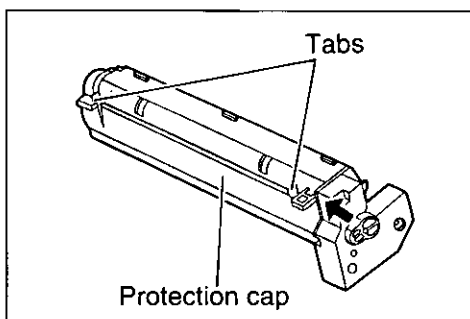

Remove the drum protection cap by pushing the right and left tabs inward.

NOTES:

– Do not touch the green drum surface under the protection cap as it may damage the drum unit.
 – Place the protection cap in the storage bag and keep it in the event that the unit must be repacked and transported (see page 175).

(continued)

7

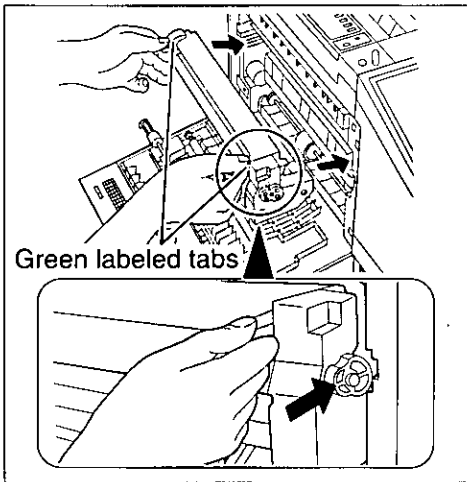

Install the drum unit by holding the green labeled tabs and pushing it firmly into place.

8

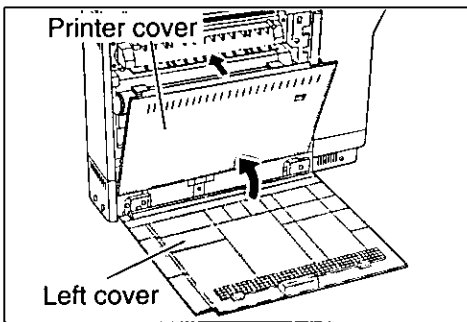

Close the printer cover and left cover.

– To close the printer cover properly, gently push on the cover where it is marked “PUSH”.

Installing the receiving tray

1

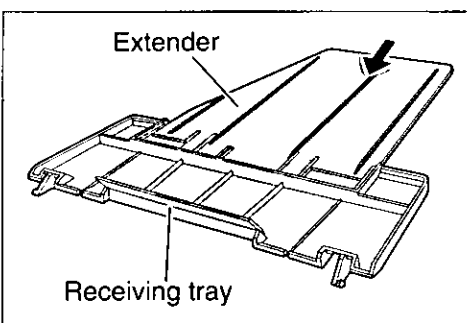

Insert the extender into the receiving tray.

2

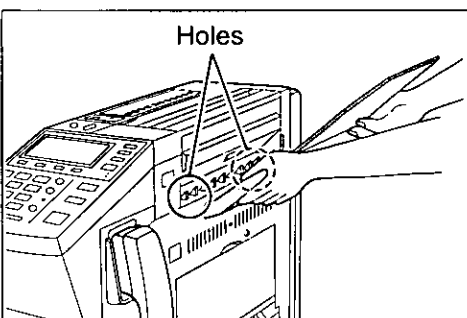

Insert the pins on the receiving tray firmly into the holes on the both sides of the unit.

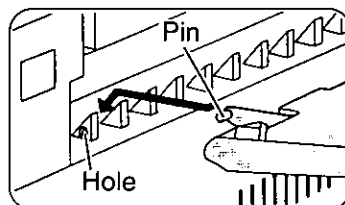

– To remove receiving tray, see page 173.

Installing the document feeder tray

1

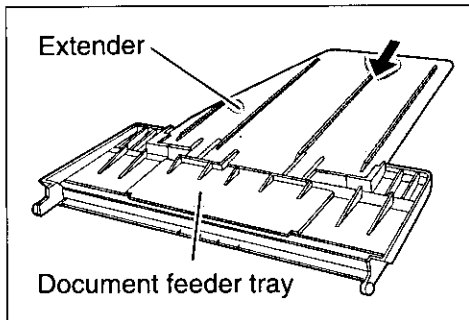

Insert the extender into the document feeder tray.

2

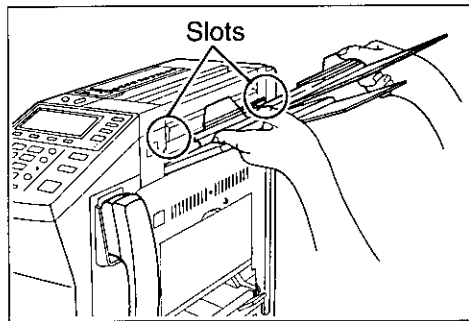

Insert the pins of the document feeder tray firmly into the slots on both sides of the unit, and the document feeder tray locks into position.

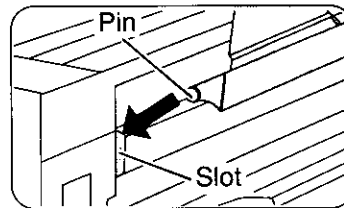

– To remove the document feeder tray, see page 173.

Installing the paper cassette and loading paper

This unit is provided with a letter-size/legal-size cassette which can hold up to 70 sheets of 75 g/m² (20 lb.) paper. Use 60 to 90 g/m² (16 to 24 lb.) paper.

IMPORTANT:

–The paper size is selected by pressing the LEGAL PAPER SUPPLY button after turning the power on and should match the size of the paper in the paper cassette. When the LEGAL PAPER SUPPLY indicator light is on, the legal-size is selected, and when the light is off, letter-size is selected. For further details on selecting the paper size, see page 29.

1

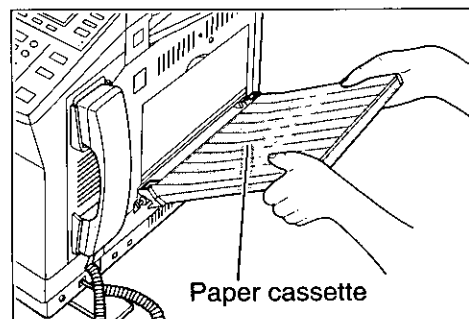

Insert the paper cassette into the unit until it clicks into place.

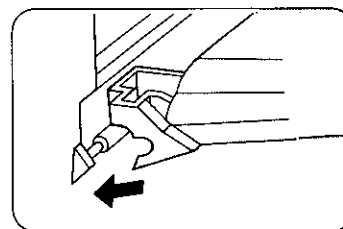

(continued)

2

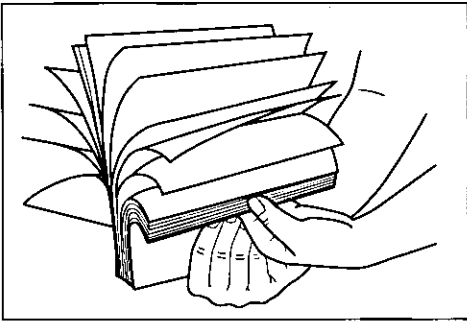

Fan the stack of paper to avoid a paper jam.

3

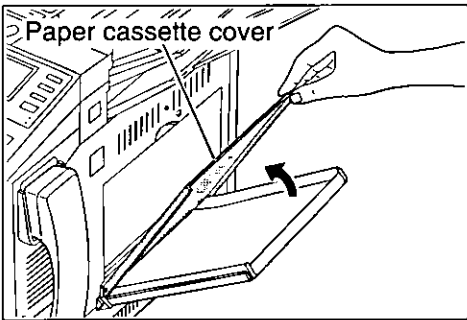

Open the paper cassette cover.

4

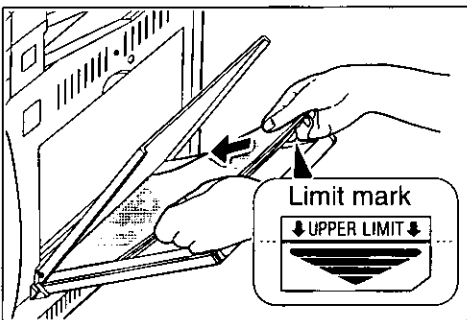

Place the paper in the paper cassette.

NOTES:

- The height of the paper should not exceed the limit mark on the paper cassette, because it may cause a paper jam.
- When using legal-size paper, see page 24.

5

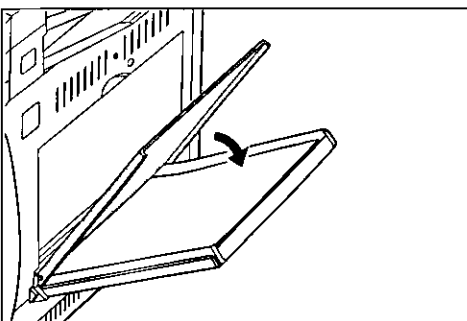

Close the paper cassette cover.

NOTES on Paper:

- Do not load paper of different thicknesses into the cassette at one time, because it may cause a paper jam.
- Make sure you load the paper with the print side up. Most paper has instructions recommending the side to be printed first.
When using 60 g/m² (16 lb.) paper, always load the paper with the "non-curl side" up rather than following the instructions on the paper package.
- When adding new paper to the paper cassette, first remove the remaining paper from the cassette and then place all of the paper together into the cassette properly.

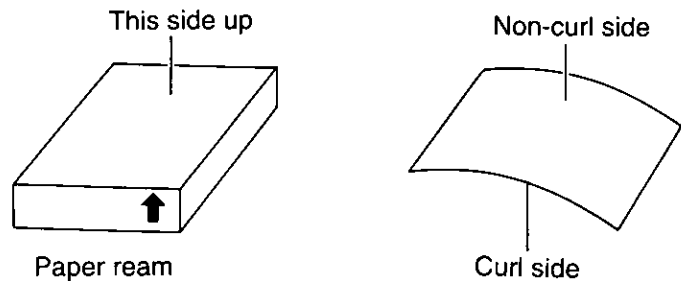

Using legal-size paper:

IMPORTANT:

- When using legal-size paper, press the LEGAL PAPER SUPPLY button after turning the power on. For further details on selecting the paper size, see page 29.

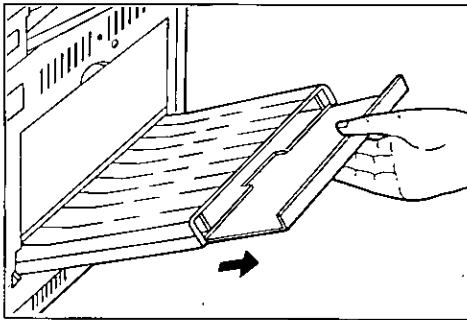

Pull out and extend the tray of the paper cassette, and then load the paper.

Types of paper to avoid:

- Extremely smooth or shiny paper or paper that is highly textured
- Coated paper
- Damaged or wrinkled paper
- Paper with a cotton and/or fiber content over 20%

For more detailed informations on types of paper, see page 182.

Printing on used paper (Double-sided printing):

Double-sided printing is possible. However, you should not expect the same print quality and reliability that results with single-sided printing. We strongly recommend following the guidelines below.

- Use 75 to 90 g/m² (20 to 24 lb.) paper. Do not use 60 g/m² (16 lb.) paper.
- The height of the paper should not exceed the limit mark on the paper cassette.
- Before loading paper in the cassette, square it so that the edges are even.

Turning the power switch on

Turn the power switch to the "I" (ON) position.

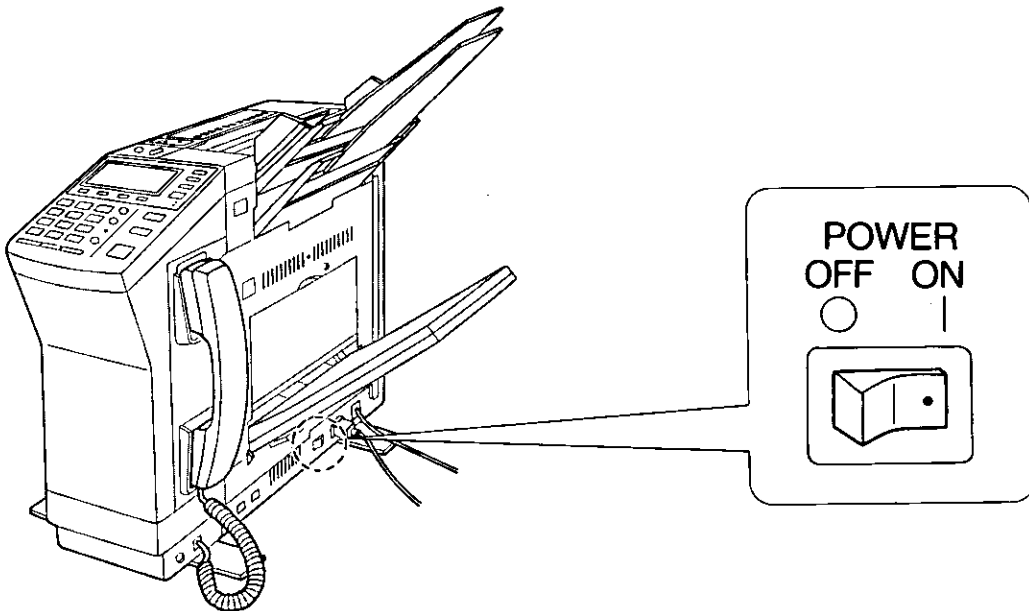

When turning the unit on, the display shows the following message for a while. After warming up, your unit will be ready to use.

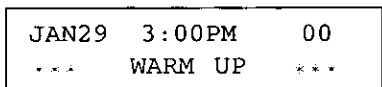

NOTE:

- If the alarm indicator light is on when you turn the power switch on, confirm that the cartridge compartment cover and the printer cover are closed firmly.

Setting selectors

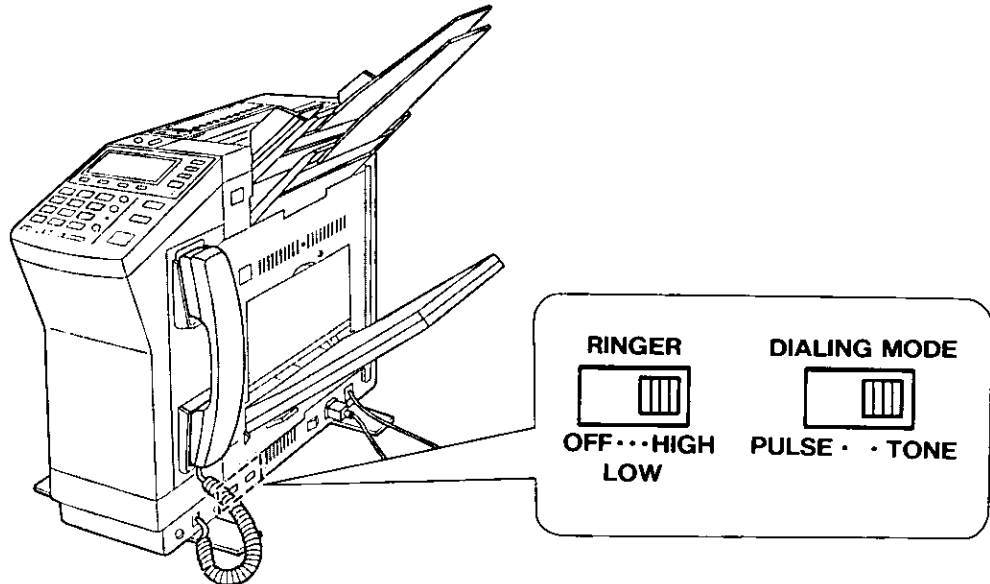

Dialing mode selector:

If your telephone line has touch tone service, set the selector to **TONE**.

If your telephone line has rotary pulse dial service, set the selector to **PULSE**.

HELPFUL HINT for dialing mode setting:

– You can ascertain what type of exchange the unit is connected to by using the following procedure:

1. Ensure that the DIALING MODE selector is set to TONE.
2. Lift the handset, then listen for the dial tone.
3. Dial a familiar number.
4. If the call is successful, the unit is connected to a tone exchange. Leave the selector set to TONE.
5. If the call is not successful, the unit is connected to a pulse exchange. Switch the selector to PULSE.

Ringer volume selector:

HIGH: The ringing sound of your unit will be loud.

LOW: The ringing sound of your unit will be soft.

OFF: The unit will not ring.

Display Indication

The unit has a liquid crystal display, which is used to view and confirm the programming state and others.

– The following display shows the possible configurations.

Amount of Memory Used:

Shows the amount of memory used (up to 99%) when using memory.

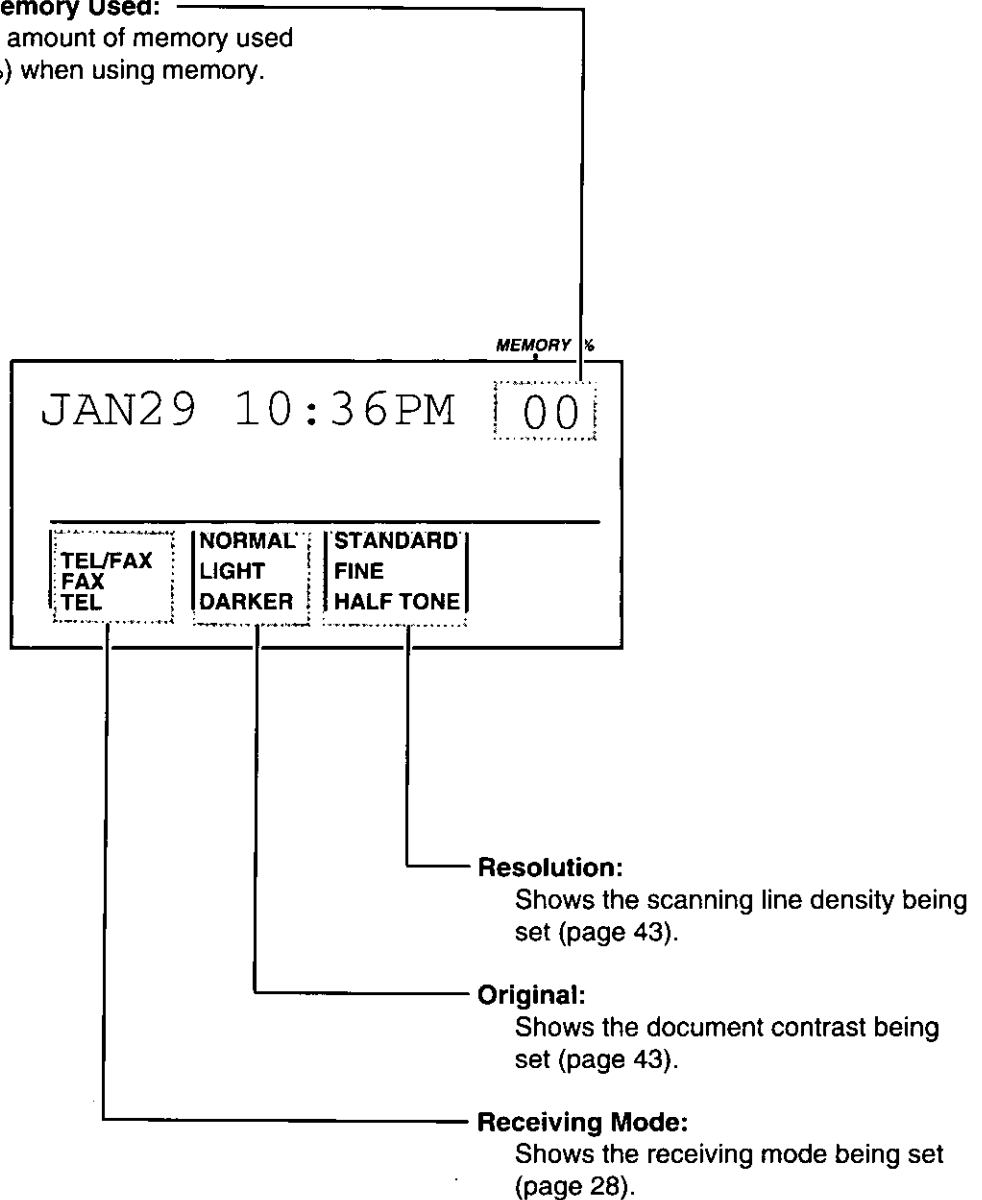

Selecting the Receiving Mode

Depending on your situation, select the desired receiving mode.

TEL/FAX mode — When you wish to use the unit as a standard telephone and a facsimile machine.

FAX mode — When you wish to use the unit as a facsimile machine only.

TEL mode — When you wish to use the unit as a standard telephone.

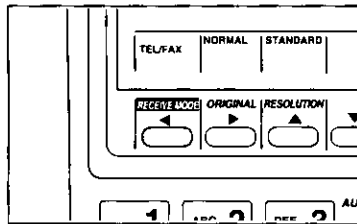

Press **RECEIVE MODE** to select the desired receiving mode.

The display shows the selected receiving mode.

When a fax or voice call comes in, the unit will function as follows:

TEL/FAX mode

- When a voice call comes in, the unit will seize the call immediately, and the unit will emit the simulated ring tones to the calling party. The caller will hear the simulated ring tones after a few second silence.
If you answer the call during ringing, you will be able to talk to the other party.
If someone does not answer the call, the unit will automatically activate the fax function. The calling party will be able to transmit a document.
- When a fax call comes in, the unit will automatically activate the fax function without ringing.

NOTES:

- Telephone fee will be charged to the calling party once the simulated ring tone is heard, because the line is already connected from that time.
- If you are connecting a reserve telephone on the same line, the reserve telephone will ring once when a call comes in. For further details on the reserve telephone, see page 118.

FAX mode

- When a fax call comes in, the unit will ring and activate the fax function.
- When a voice call comes in, the unit will ring and emit a fax tone to the calling party. The calling party will be able to transmit a document. You cannot talk to the other party.

NOTE:

- Inform your callers that your unit is used for a facsimile machine only.

TEL mode

- When a call comes in, you will have to answer every call.
- When you answer a call and the pip tones are heard or nothing is heard, the call may be a fax call. Press the START button to receive a document.

NOTE:

- If someone calls your unit until the unit rings 15 times, the receiving mode of the unit will be changed to the *TEL/FAX* mode from the *TEL* mode automatically.

Making calls and transmitting documents are possible in every receiving mode.

Selecting the Paper Size

The paper size is selected by pressing the LEGAL PAPER SUPPLY button and should match the size of the paper in the paper cassette.

Pressing the LEGAL PAPER SUPPLY button alternates between letter-size and legal-size paper. The LEGAL PAPER SUPPLY indicator and the display show the paper size selected.

■ LEGAL PAPER SUPPLY indicator:

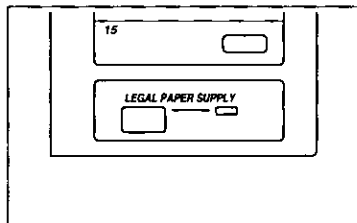

Light off ... Letter-size is selected.

Light on ... Legal-size is selected.

■ Display:

PAPER SUPPLY
=LETTER SIZE

or

PAPER SUPPLY
=LEGAL SIZE

The display shows the selected paper size for 5 seconds after pressing the LEGAL PAPER SUPPLY button.

CAUTION:

– If the unit has been set to print on legal-size paper but letter-size paper is installed, the unit will not print and the display will show the following message:

CHECK PAPER SIZE
PRESS MENU KEY

(While receiving)

or

CHECK PAPER SIZE
PRESS STOP/CLEAR

(While copying)

See page 146 to continue printing. If you press the LEGAL PAPER SUPPLY button to change the paper size setting while the above message is displayed, the first page will be deleted.

System Programming Features

The unit has the following features, and they are divided into the basic and advanced features.

Basic features are the settings that need to be programmed upon finishing the installation. Most of the probable choices have already been pre-selected, but some features such as the current date and time, the company name or personal name, and your facsimile telephone number, must be programmed by the user.

Advanced features should be programmed as the need arises.

Before using your unit as a facsimile, always set the following features:

- #01 The current date and time (page 33)
- #02 Your company name or personal name (page 34)
- #03 Your facsimile telephone number (page 34)

HELPFUL HINT:

- If you lose your instructions while programming the basic features, press the HELP button. The unit will print information on how to program (see page 8).

Basic features

The underlined selections indicate the pre-selected settings.

Program No.	Functions	Indications	Selections	Pages
#01	The current date and time	SET DATE	<u> </u>	33
#02	Your company name or personal name	YOUR LOGO	up to 30 characters	34
#03	Your facsimile telephone number	YOUR TELEPHONE NUMBER	up to 20 digits	34
#04	Individual transmission report	PRINT TRANSMISSION REPORT	<u>Error</u> / On / Off	120
#05	Memory transmission	MEMORY XMT	On / <u>Off</u>	93
#06	Number of rings to answer in the FAX mode	FAX RING COUNT	1 to 4 rings (<u>1</u> ring)	122

Advanced features

1

The underlined selections indicate the pre-selected settings.

Program No.	Functions	Indications	Selections	Pages
#10	Logo print position on the transmitted document	LOGO POSITION	<u>Out</u> / In	123
#11	Auto/Manual journal report printing	JOURNAL AUTO PRINT	<u>Auto</u> / Manual	124
#12	Passcode for network communication	NETWORK PASSCODE	4 digits (<u>0000</u>)	98
#13	Transmission passcode check mode for network communication	TX PASSCODE CHECK	On / <u>Off</u>	99
#14	Reception passcode check mode for network communication	RX PASSCODE CHECK	On / <u>Off</u>	100
#15	Passcode for polling function	POLLING PASSCODE	4 digits (<u>0000</u>)	88
#16	Number of the silent fax recognition ring	SILENT FAX RECOGNITION RING	3 to 8 rings (<u>3 rings</u>)	127
#18	Personal message for the customized header	ENTER MESSAGE D	up to 64 characters	109
#19	Copy mode	COPY MODE	<u>Reduction (REDT)</u> or Inhibition (INH) or Extension (EXTND)	128, 130
#20	Reduction mode for receiving fax	RX REDUCTION	92% Reduction (RED 1) or <u>72% Reduction (RED 2)</u> or Inhibition (INH)	132

Advanced features (cont.)

The underlined selections indicate the pre-selected settings.

Program No.	Functions	Indications	Selections	Pages
#21	Fax forwarding mode and forwarding facsimile telephone number	FAX FORWARDING	On / <u>Off</u>	101
#23	Distinctive ring pattern of the fax call for the automatic reception	RING PATTERN DETECTION	A: Standard ring or B: Double ring or C: Triple ring or D: Other triple ring or <u>Off</u>	134
#24	Brightness of the display	LCD CONTRAST	Light (LIGH) or <u>Normal (NORM)</u> or Dark (DARK)	136
#27	Number of rings of the reserve phone to answer in the TEL/FAX mode	TEL/FAX DELAYED RING	1 to 4 rings (<u>1 ring</u>)	137
#28	Maximum transmission speed	TX SPEED	A: <u>9600 bps</u> B: 7200 bps C: 4800 bps D: 2400 bps	139
#29	Message alert setting	MESSAGE ALERT	<u>On</u> / Off	140
#50	Reset of the basic and advanced features to the initial settings (Except for the basic features #01 to #03)	SET DEFAULT	Yes / <u>No</u>	141

Setting date and time

The internal clock of the unit will print the date and time on the top line of all fax communication messages you transmit and fax reports, such as the journal report and the transmission report.

HELPFUL HINT:

- If you lose your instructions while setting, press the HELP button. The unit will print information on how to set.

1

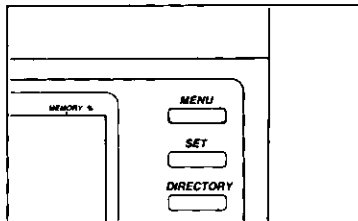

Press **MENU** until the following is shown.

```

PROG. [1.DATE 2.TEL
3.SYSTEM 4.REPORT]
    
```

2

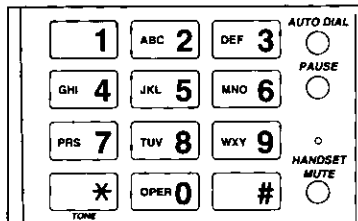

Press **1** to start programming.

```

SET DATE[.=AM #=PM]
01 29 94 10:36PM SAT
    
```

3

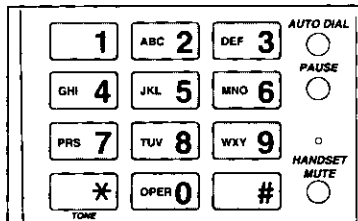

Enter the current month/day/year/hour/minute by selecting 2 digits each.

Example: Aug. 10 1994, 3:00PM.

Press **08, 10, 94, 03**, then press **00**.

Press **#** to select PM mode.

```

SET DATE[.=AM #=PM]
08 10 94 03:00PM WED
    
```

- It is not necessary to enter a day of the week.
- To select AM mode, press *.
- If you make a mistake, use the cursor key (◀ or ▶) to move the cursor to the incorrect number, then make the correction.

4

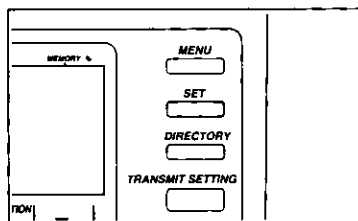

Press **SET** to store the program into memory.

```

PROG. [1.DATE 2.TEL
3.SYSTEM 4.REPORT]
    
```

(continued)

5

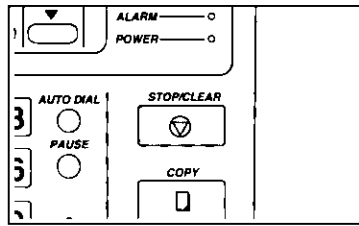

Press **STOP/CLEAR** to end the programming.

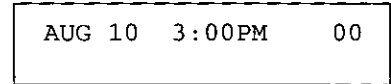

NOTES:

- To cancel programming halfway, press the MENU button.
- The accuracy of the internal clock will be approximately ± 60 seconds a month in the operating environment.

Setting your logo and facsimile telephone number

Your logo: The logo is used to identify fax messages that are being transmitted by your unit. It may consist of alpha-numeric letters and symbols. Usually the logo is a company, division, or personal name in an abbreviated form. The printed logo can be up to 30 characters in length.

Your facsimile telephone number: Your facsimile telephone number can be programmed into your unit. The unit can store the number up to 20 digits in length.

Your programmed logo and telephone number will be printed on the top of each page transmitted from your unit, along with the date, time, and page number.

This will give the receiving party your name and fax telephone number if they wish to return a fax.

Sample page sent by your unit:

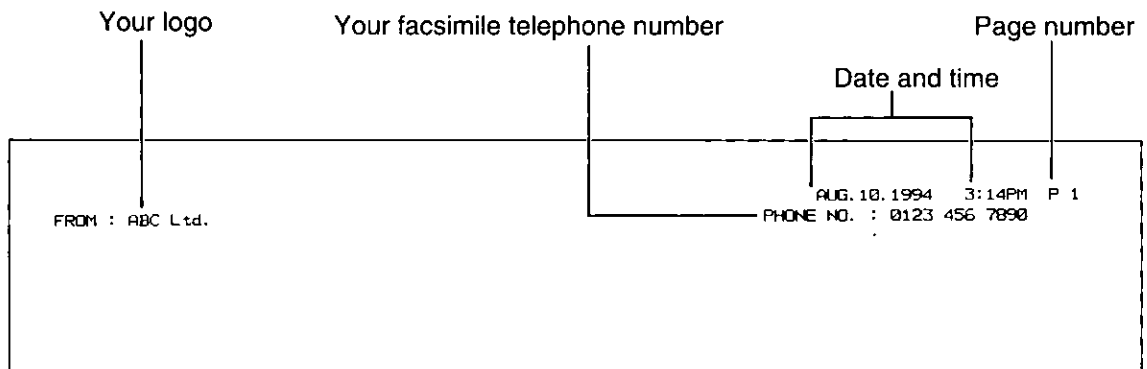

To set your logo and facsimile telephone number, proceed as follows:

HELPFUL HINT:

- If you lose your instructions while setting, press the HELP button.
- The unit will print information on how to set.

1

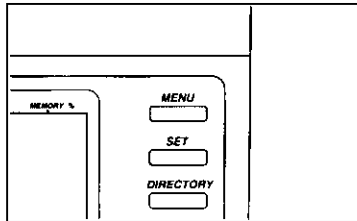

Press **MENU** until the following is shown.

```

PROG. [1.DATE 2.TEL
3.SYSTEM 4.REPORT]
  
```

2

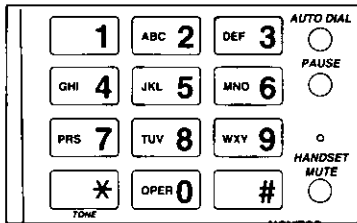

Press **3** to start programming.

```

ENTER YOUR LOGO
=QUASAR PPX
  
```

- The unit is pre-programmed to "QUASAR PPX" as your logo.

3

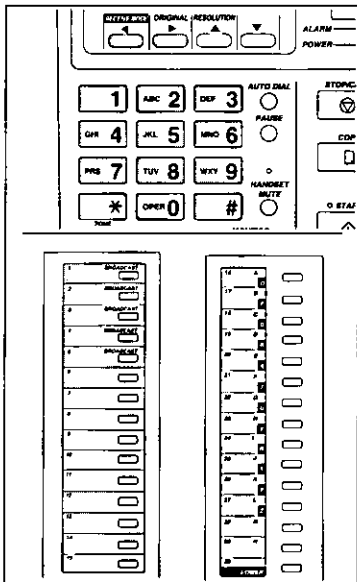

Enter your logo up to 30 characters by using the character keys and the cursor key (◀ or ▶).

- When the first character is entered, the pre-programmed logo is cleared.

Example: The logo is ABC Ltd.

1. Press **2** once to select "A" then ▶ .
2. Press **2** twice to select "B" then ▶ .
3. Press **2** three times to select "C" then ▶ .
4. Press the station number **9** of the direct call station key to select "space" then ▶ .
5. Press **5** three times to select "L" then ▶ .
6. Press **8** four times to select "t" then ▶ .
7. Press **3** four times to select "d" then ▶ .
8. Press the station number **3** four times to select "." (period).

```

ENTER YOUR LOGO
=ABC Ltd.
  
```

- For further details on using the character keys, the command keys, and the cursor key (◀ or ▶), see pages 37 to 40.
- If you make a mistake, use the cursor key (◀ or ▶) to move the cursor to the incorrect character, then make the correction.

(continued)

4

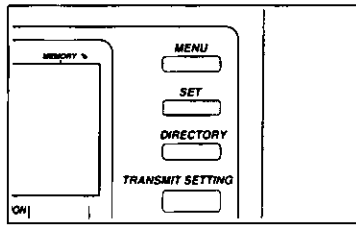

Press **SET** to store the program into memory.

```

ENTER YOUR TEL #
=
  
```

5

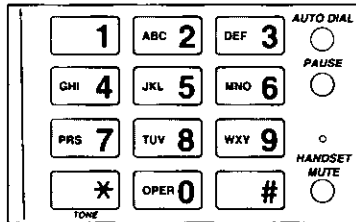

Enter your facsimile telephone number up to 20 digits by using the dial keypad.

Example: If the phone number is 0123 456 7890, press **0123, #, 456, #**, then press **7890**.

```

ENTER YOUR TEL #
=0123 456 7890
  
```

- Pressing the # button provides one space and pressing the * button provides the mark "+".
- If you make a mistake, use the cursor key (◀ or ▶) to move the cursor to the incorrect number, then make the correction.

6

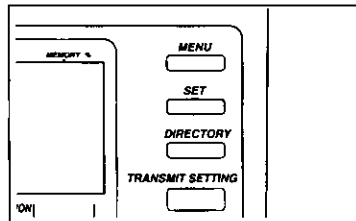

Press **SET** to store the program into memory.

```

XMT REPORT =ERROR
[1.ERROR 2.ON 3.OFF]
  
```

7

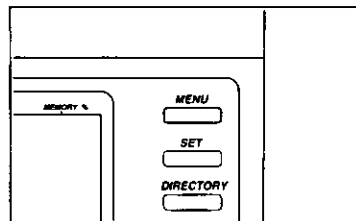

Press **MENU** to end the programming.

NOTE:

- To cancel programming halfway, press the MENU button.

How to use the character keys

The dial keypad and the direct call station keys are also used as alphabet and symbol character input keys when programming your logo, the direct call station names, and the speed dial station names.

NOTE:

- The character layout of the direct call station keys is printed on the reverse side of the directory card.
- 1. Remove the directory card cover with a pen or pin or similar object as shown.
- 2. Turn the directory card over.

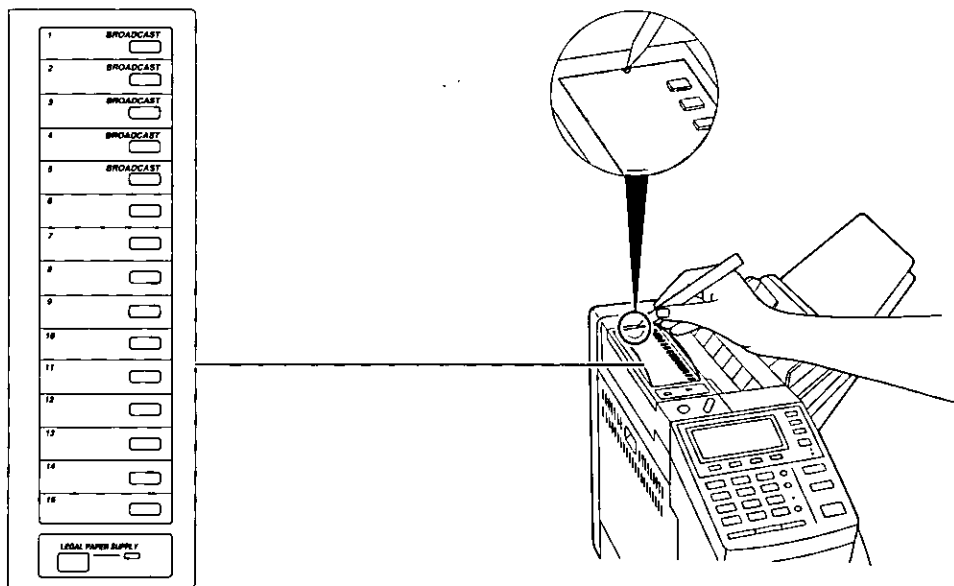

To enter all characters in capitals:

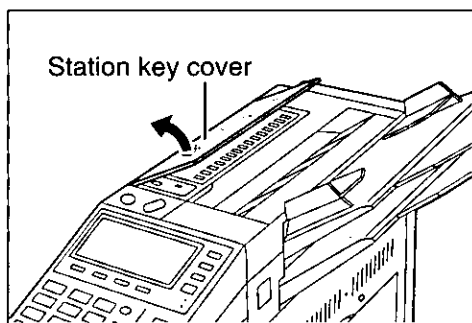

Open the station key cover and enter the character in capitals.

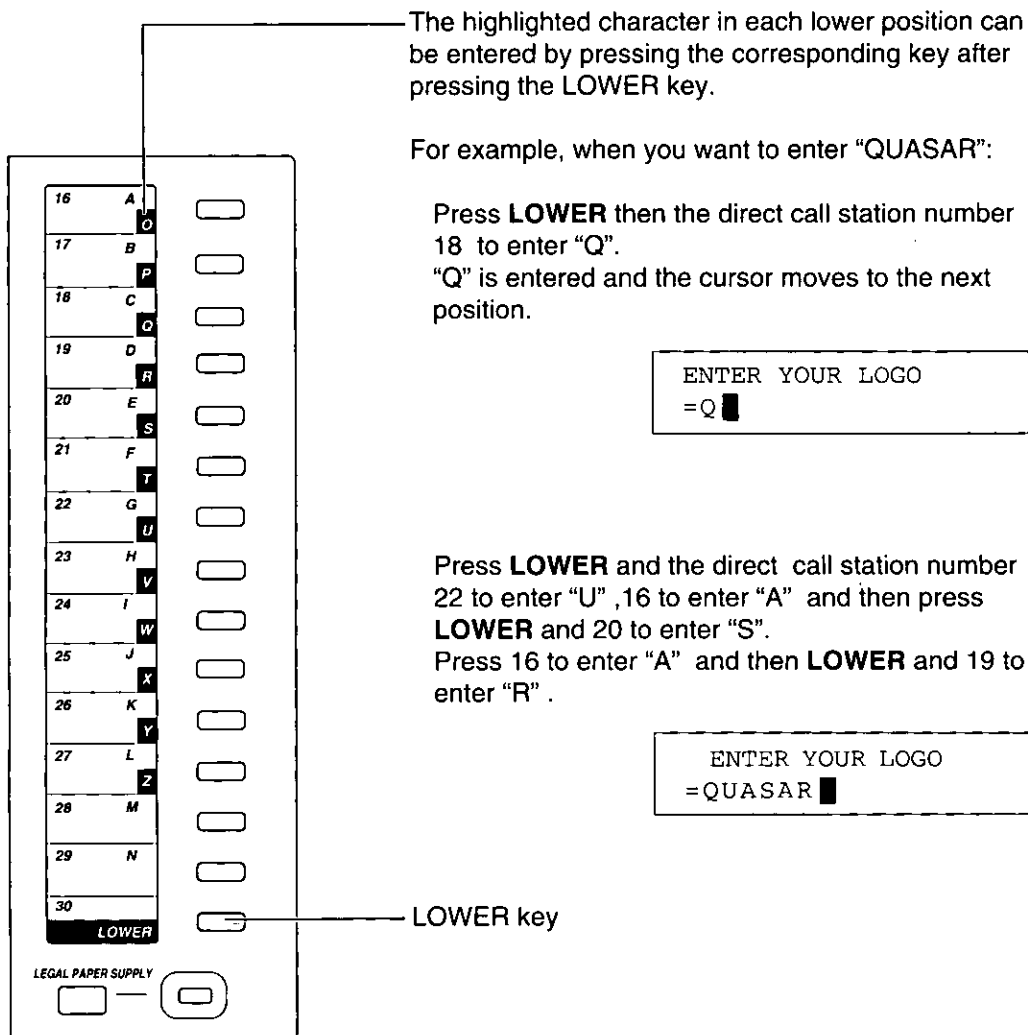

NOTE:

- If you make a mistake, use the cursor key (◀ or ▶) to move the cursor to the incorrect character, then make the correction. The character on the cursor position will be replaced with the new entry.

To enter numbers, symbols, and characters including small letters:

Close the station key cover, and enter the characters shown on the next page.

■ **Cursor keys**

◀ **key (RECEIVE MODE button):**

The cursor is moved one space to the left each time you press this key.

▶ **key (ORIGINAL button):**

The cursor is moved one space to the right each time you press this key.

■ **Character keys**

The character on the display is changed each time you press one of these keys.

For example, when you press **2** repeatedly, the display shows:

A → B → C → a → b → c → 2 → A

To enter a character and move to the next character, press ▶ (ORIGINAL button) once.

■ **Command keys**

SPACE key:

This key is used to replace one character to the space.

BACK SPACE key:

This key is used to delete one character to the left side of the cursor while it moves backward.

e.g., Quasuar → Quasar

1. Press ◀ repeatedly until the cursor is positioned on "a".

ENTER YOUR LOGO
=Quasar

2. Press **BACK SPACE**.

ENTER YOUR LOGO
=Quasar

SECRET key:

To keep a phone number secret while storing it into memory for automatic dialer, press the **SECRET** key at the beginning and end of the phone number.

For further details, see page 65.

DISPLAY CLEAR key:

This key is used to erase all the characters entered.

HYPHEN Key:

This key is used to enter a hyphen.

INSERT key:

This key is used to insert one character or one space.

e.g., Qusar → Qusar

1. Press ◀ repeatedly until the cursor is positioned on "s".

ENTER YOUR LOGO
=Qusar

2. Press **INSERT**, then press **2** repeatedly until "a" is shown.

ENTER YOUR LOGO
=Qusar

DELETE key:

This key is used to delete one character.

e.g., Quasar → Qusar

1. Press ◀ repeatedly until the cursor is positioned on "s".

ENTER YOUR LOGO
=Qusar

2. Press **DELETE**.

ENTER YOUR LOGO
=Qusar

Dial Keypad

Keypad:	Character:	Keypad:	Character:	Keypad:	Character:
<input type="text" value="1"/>	...1	<input type="text" value="ABC 2"/>	...A B C a b c.2	<input type="text" value="DEF 3"/>	...D E F d e f 3
<input type="text" value="GHI 4"/>	...G H I g h i 4	<input type="text" value="JKL 5"/>	...J K L j k l 5	<input type="text" value="MNO 6"/>	...M N O m n o 6
<input type="text" value="PRS 7"/>	...P Q R S p q r s 7	<input type="text" value="TUV 8"/>	...T U V t u v 8	<input type="text" value="WXY 9"/>	...W X Y Z w x y z 9
<input type="text" value="*"/>	...*	<input type="text" value="OPER 0"/>	...0	<input type="text" value="#"/>	...#

Direct Call Station Keys

To enter the following characters, close the station key cover.

– These characters layout is printed on the reverse side of the directory card. See page 37.

	Character:
Character keys	<input type="text" value="1 Q Z q z ! + BROADCAST"/> Q Z q z ! +
	<input ,="" broadcast"="" type="text" value="2 = ' "/> = ' " ,
	<input type="text" value="3 ? ! \$. BROADCAST"/> ? ! \$.
	<input type="text" value="4 @ T % / BROADCAST"/> @ → % /
	<input type="text" value="5 ¥ & : ^ BROADCAST"/> ¥ & : ^
	<input type="text" value="6 ' ; _ -"/> ' ; _ -
	<input type="text" value="7 () < >"/> () < >
	<input type="text" value="8 [] { }"/> [] { }
Command keys	<input type="text" value="9 SPACE"/> SPACE
	<input type="text" value="10 HYPHEN"/> HYPHEN
	<input type="text" value="11 BACK SPACE * SECRET"/> BACK SPACE · SECRET
	<input type="text" value="12 DISPLAY CLEAR"/> DISPLAY CLEAR
	<input type="text" value="13 DELETE"/> DELETE
	<input type="text" value="14 INSERT"/> INSERT
	<input type="text" value="15"/>

Chapter 2

Basic Instructions

Contents

	Page
<i>Facsimile</i>	
Transmitting Documents	42
Before transmitting documents	42
Manual transmission (Case 1)	45
Redialing the last dialed number	46
Manual transmission (Case 2)	47
Receiving Documents	48
Manual reception	48
Automatic reception	49
Receiving over-sized documents	51
Memory reception	52
<i>Copier</i>	
Making Copies	53
<i>Telephone</i>	
Making and Answering Voice Calls	54
Making voice calls	54
Redialing the last dialed number	56
Answering voice calls	56

Transmitting Documents

HELPFUL HINT:

- You can transmit documents manually and automatically. To make the automatic transmission, you need to store phone numbers first. See page 58.

Before transmitting documents

Acceptable documents:

The unit can transmit documents that meet the following conditions:

- Document width should be from 128 to 216 mm (5" to 8½").
- Maximum document length should not exceed 660 mm (26").
- Effective scanning width can be up to 208 mm (8¾").
- Number of pages that can be set in the document feeder tray must not exceed 20 pages.
- Document weight:
 - Single sheet: 45 to 90 g/m² (12 to 24 lb.)
 - Multiple sheets: 60 to 75 g/m² (16 to 20 lb.)

Minimum document size

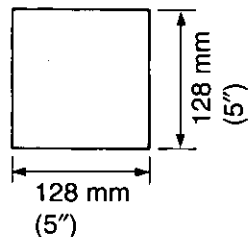

Maximum document size

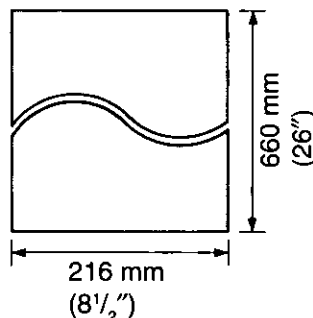

Effective scanning width

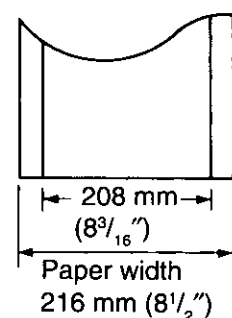

Unacceptable documents:

The following documents may cause a jam:

- Documents bound with clips, staples, or other similar objects
- Documents on which ink, paste, or correction fluid has not completely dried

Do not use the following types of documents. Make a clear copy of these documents and then feed the copy into the unit.

- Paper with a chemically treated surface, such as carbon paper or carbonless duplicating paper
- Electrostatically charged paper
- Heavily curled, creased, or torn paper
- Paper with a coated surface
- Small-sized paper such as a slip or voucher
- Thin paper less than 45 g/m² (12 lb.)
- Thick paper over 90 g/m² (24 lb.)
- Paper with faint contrast between the print and the background
- Paper with printing on the reverse side that can be seen through the front (e.g. newspaper)

Contrast and resolution:

You can set the contrast and resolution modes, depending on the quality of the original. Set these modes before transmission or copying. If they are set during transmission, they will be effective from the next page scanned.

The display shows the current settings of the contrast and resolution modes.

Contrast:

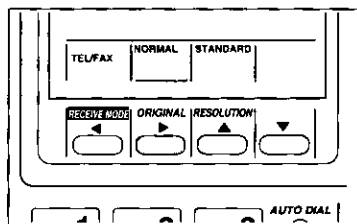

Press **ORIGINAL** to change the contrast mode.

NORMAL is suitable for originals with normal writing.

LIGHT is suitable for originals with faint writing.

DARKER is suitable for originals with dark writing.

- The contrast mode automatically returns to the normal mode after transmission or copying.
- When you set the LIGHT or DARKER mode, it may take longer time to transmit documents.

Resolution:

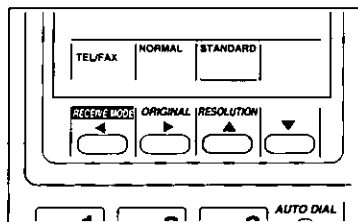

Press **RESOLUTION** to change the resolution mode.

STANDARD is suitable for printed or typewritten originals with normal-sized characters.

FINE is suitable for originals with small printed characters or detailed drawings.

HALF TONE is suitable for originals containing photographs, shaded drawings, etc.

- The resolution mode automatically returns to the standard mode after transmission or copying.
- When you set the FINE or HALF TONE mode, it takes longer time to transmit documents has been completed.

Loading documents:

1

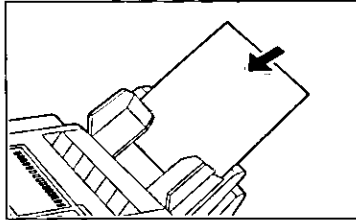

Insert the documents **FACE DOWN** into the document feeder tray.

A beep is heard.

– The unit can accept up to 20 pages at a time.

2

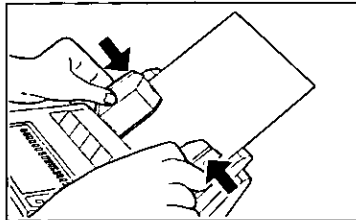

Adjust the document guides to the width of the documents.

3

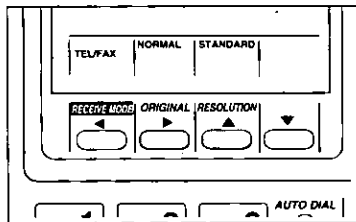

Set the contrast or resolution mode by using **ORIGINAL** or **RESOLUTION** if needed.

4

Start the transmitting operation.

Adding extra pages:

If you want to send 21 or more pages at a time, insert the first 20 pages of the document and add the extra pages, up to 20 pages at a time, before the last page is fed into the unit.

Manual transmission (Case 1)

1

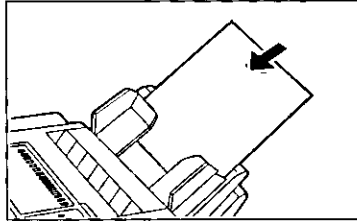

Insert the documents FACE DOWN.

A beep is heard.

– The unit can accept up to 20 pages at a time.

2

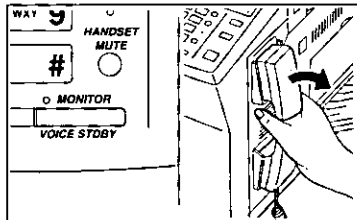

Press **MONITOR** or lift the handset, and listen for the dial tone.

AUG10	3:00PM	00
ENTER PHONE NUMBER		

– If pressing **MONITOR**, the MONITOR indicator light will be on.

3

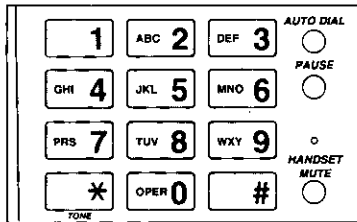

Dial the phone number of the receiving party.

Example: 1234567 is dialed.

AUG10	3:00PM	00
1234567		

– If the other party answers, lift the handset and ask them to press their start or transmit button to start the fax reception.

– If you misdialed, press **FLASH** firmly. The dial tone will sound, and dial the correct number.

4

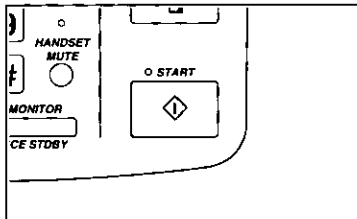

Press **START** when a fax tone is heard.

The START indicator light is flashing.

SENDING	P 1
TO:1234567	

5

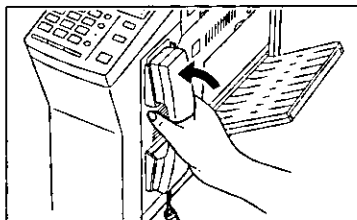

Place the handset on the cradle if using it.

The unit will feed and transmit the documents. The START indicator light is on, and the light goes out after the transmission.

2

Interrupting transmission:

Press the STOP/CLEAR button until a beep sounds. To eject the document, press the STOP/CLEAR button again.

Redialing the last dialed number

If the line is busy or you wish to redial the last dialed number, press the REDIAL button.

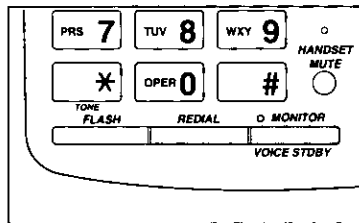

After pressing **MONITOR** or lifting the handset, press **REDIAL**.

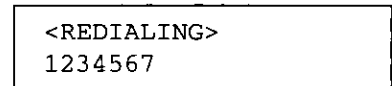

NOTES:

- When using the handset, the unit redials the number once.
- When using on-hook dialing, the unit redials the number. If the line is busy, the unit will automatically redial the number. See the item number 8 on page 181. The MONITOR indicator light flashes and the following display is shown while waiting for the redialing:

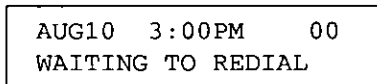

- To cancel the redialing, press the STOP/CLEAR button.

Manual transmission (Case 2)

You can also access the other party's facsimile without using the handset or the MONITOR button.

This feature can transmit a document using less procedures.

1

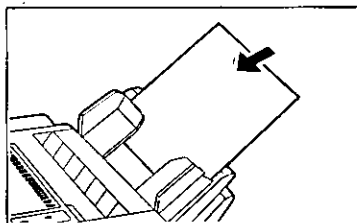

Insert the documents FACE DOWN.

A beep is heard.

– The unit can accept up to 20 pages at a time.

2



Enter the phone number of the receiving party.

Example: 1234567 is dialed.

AUG10	3:00PM	00
1234567		

– Confirm in the display whether the phone number is correctly entered.

– If you misdialed, press **STOP/CLEAR**, then enter the correct number.

3

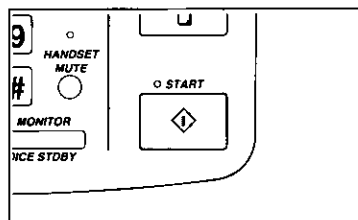

Press **START**.

The unit dials and transmits the documents.

The **START** indicator light changes from flashing to steady.

Interrupting transmission:

– Press the **STOP/CLEAR** button until a beep sounds. To eject the document, press the **STOP/CLEAR** button again.

NOTES:

– If there is no answer or the line is busy, the unit will automatically redial the number. See the item number 7 on page 181.

– To cancel the redialing, press the **STOP/CLEAR** button.

HELPFUL HINTS for overseas transmission:

– Set the overseas transmission mode (see page 107).

– When dialing the phone number, add two pauses at the end of the number by pressing the **PAUSE** button.

2

Receiving Documents

CAUTIONS:

- In order to avoid a paper jam, do not open the printer cover while printing.
- Do not load recording paper while the unit is feeding paper.

Manual reception

Receiving in the TEL mode and other modes:

You can receive fax messages manually as follows:

1



When the phone rings, lift the handset to answer the call.

2

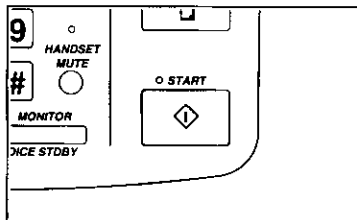

When a voice is heard and document reception is required, press **START**.

The START indicator light is flashing.

3

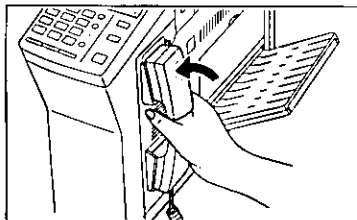

Place the handset on the cradle.

The unit starts receiving the fax.

The START indicator light is on while receiving the fax, and the light goes out after the reception has been completed.

NOTES:

- To interrupt reception, press the STOP/CLEAR button. The unit will stop receiving.
- If someone does not answer the call in the TEL mode within 15 rings, the unit will automatically switch to the TEL/FAX mode.

Automatic reception

When receiving a fax call, the unit will automatically activate the fax function, then initiate reception.

Set the receiving mode to any of the following modes by pressing the RECEIVE MODE button:

- TEL/FAX mode
- FAX mode

CAUTION:

- Do not let more than 70 sheets of 75 g/m² (20 lb.) paper accumulate at one time in the receiving tray. This may cause a paper jam.

NOTE:

- While programming or printing, the unit will not receive documents automatically. The unit will ring until you answer the call.

Receiving in the TEL/FAX mode:

1

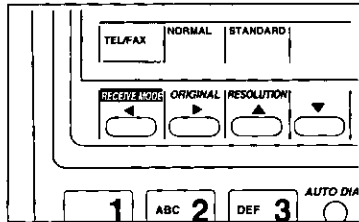

Make sure that the unit is in the *TEL/FAX* mode.

- The current receiving mode is shown on the display.

2

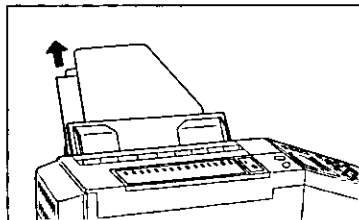

- **When receiving a fax call,** the unit automatically activates the fax function to receive the documents.

The START indicator light is flashing, and then the light is on while receiving the documents.

or

or

(continued)

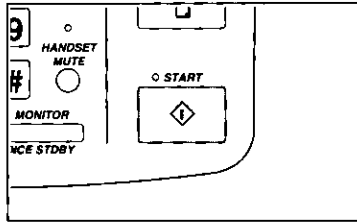

■ **When receiving a telephone call,** the unit rings depending on the setting of the silent fax recognition ring. You can change the ring count. See page 127.

- If a fax reception is required or nothing is heard after answering the call, press **START** to receive a fax. Then replace the handset if using it.
- If someone does not answer the call, the unit will automatically activate the fax function to receive documents.

NOTES:

- A telephone fee is charged to callers from the first ring.
- The unit can distinguish between a voice and fax call by detecting the calling tone (CNG), sent by the transmitting fax machines.
Some fax messages that are transmitted manually may be received after the unit rings, because some fax machines do not send calling tone in manual mode.

Receiving in the FAX mode:

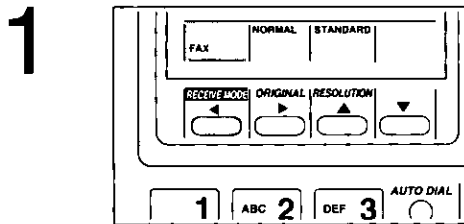

Make sure that the unit is in the *FAX* mode.

- The current receiving mode is shown on the display.

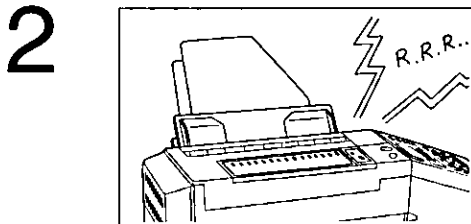

A call comes in.

- The unit answers the call after rings, depending on the setting of the number of rings in the *FAX* mode.
You can change the ring count. See page 122.

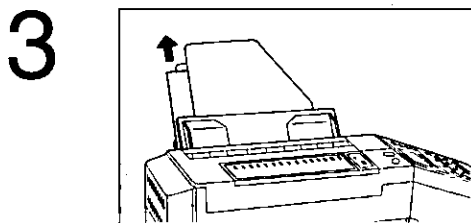

The unit produces a fax tone, then starts receiving the documents.

The **START** indicator light is flashing, and then the light is on while receiving the documents.

Receiving over-sized documents

You may be sent a document that is longer than one 216×279 mm ($8\frac{1}{2}$ " \times 11") standard sheet of paper. In this case, the unit will automatically reduce the document in length to fit on one page or divide it into two or more pages when printing out (automatic reduction feature).

Printouts on letter-size paper:

Incoming document transmitted	Letter-size 216 \times 279 mm ($8\frac{1}{2}$ " \times 11")	A4 size 210 \times 297 mm ($8\frac{1}{4}$ " \times $11\frac{11}{16}$ ")	Legal-size 216 \times 356 mm ($8\frac{1}{2}$ " \times 14")	Longer than 370 mm ($14\frac{9}{16}$ ")
	↓	↓	↓	↓
Printout for receiving	Reduced to 92%	Reduced to 86%	Reduced to 72%	Divided (First page)
				Divided (Second page)

Printouts on legal-size paper:

Incoming document transmitted	Letter-size 216 \times 279 mm ($8\frac{1}{2}$ " \times 11")	A4 size 210 \times 297 mm ($8\frac{1}{4}$ " \times $11\frac{11}{16}$ ")	Legal-size 216 \times 356 mm ($8\frac{1}{2}$ " \times 14")	Longer than 370 mm ($14\frac{9}{16}$ ")
	↓	↓	↓	↓
Printout for receiving	Not reduced	Not reduced	Reduced to 92%	Divided (First page)
				Divided (Second page)

NOTES

- To extend the reduced document to actual size, see pages 128 and 130 and perform the extension copy.
- If you wish to receive documents in actual size, the automatic reduction feature can be turned off. For details, see page 132.

Memory reception

If the paper runs out or a paper jam occurs during a reception, the unit will temporarily store a continuation of the documents. The stored documents will print out automatically after the paper is supplied or the paper jam is cleared. While the unit keeps the documents in memory, a slow beep of the message alert will sound.

- Concerning the memory capacity for storing documents, see page 7.

NOTES:

- If memory becomes full during a reception, the unit will stop receiving documents and display the following message:

```
AUG10  3:00PM  99
*** MEMORY FULL ***
```

- Print the stored documents to clear the memory.
- If a power failure occurs or you turn the power switch off, all stored documents will be lost. The unit automatically prints out a power-down report telling which transaction has been lost after the power is restored. See page 159.
 - To de-activate the message alert feature, see page 140.

Making Copies

The unit can make single or multiple copies up to 70 sheets. Any transmissible document can be copied. See page 42.

CAUTION:

– In order to avoid a paper jam, do not open the printer cover while printing.

1

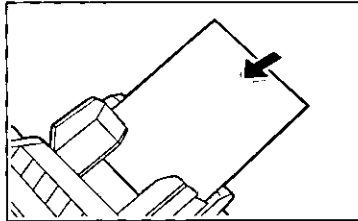

Insert the documents FACE DOWN.

- The unit can accept up to 20 pages at a time.
- You can set the contrast and resolution modes. See page 43.

2

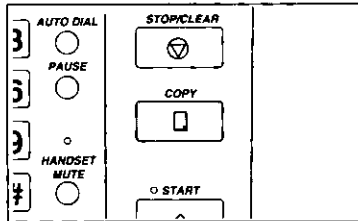

Press **COPY**.

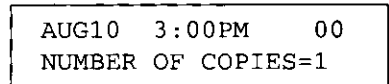

- If you need two or more copies, enter the number of copies (up to 70).

3

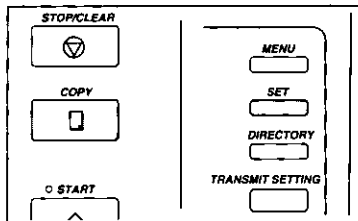

Press **COPY** or **SET**.

The unit feeds the documents, and then starts making copies.

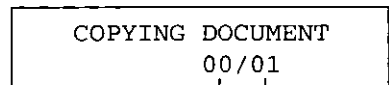

Printed pages —
Number of copies —

Interrupting a copy:

Press the STOP/CLEAR button while making copies until a beep is heard. To eject the document, press the STOP/CLEAR button again.

NOTES:

- When copying, the unit automatically selects the fine resolution, but you may use the halftone resolution.
- If you wish to copy 21 or more pages at a time, insert the first 20 pages of the document and add the extra pages up to 20 pages at a time, before the last page is fed into the unit.
- You can make or receive voice calls while making copies.
- While activating the fax communication, the unit cannot make copies.
- While making copies, the unit cannot activate the automatic reception.

2

Making and Answering Voice Calls

Making voice calls

Using the handset:

1. Lift the handset and listen for the dial tone.

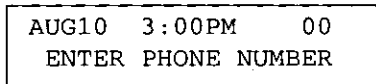

2. Dial the phone number.
3. When finished, replace the handset on the cradle.

Using on-hook dialing:

1

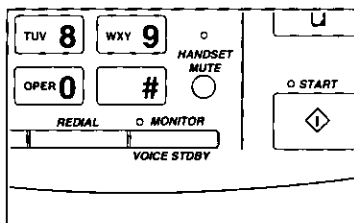

Press **MONITOR** and listen for the dial tone.

The MONITOR indicator light is on.

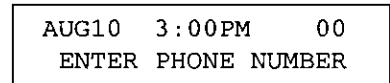

2

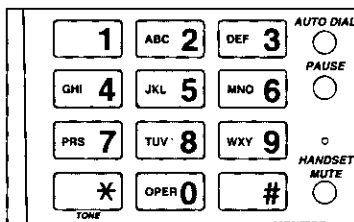

Dial the phone number.

The dialed number is displayed.

Example: 1234567 is dialed.

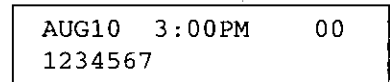

3



When the other party answers your call, lift the handset and talk into it.

– If you do not lift the handset, you can hear the other party but they cannot hear you.

4

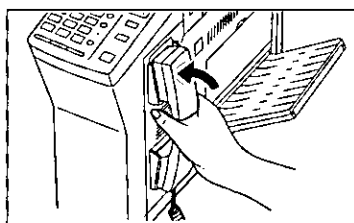

When finished, replace the handset on the cradle.

Adjusting the volume level:

You can adjust the volume level of the handset receiver or speaker by pressing the VOLUME control button (Δ , ∇) during a conversation. When using the handset, 3 levels are available (High, Rather High, and Normal). When using on-hook dialing, 8 levels are available. The volume level is shown on the display as follows:

To raise the volume level:

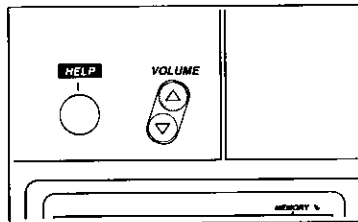

Press Δ .

- Each press of Δ increases one black square mark on the display.

When using the handset:

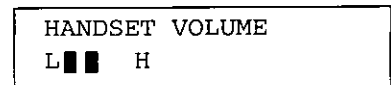

When using on-hook dialing:

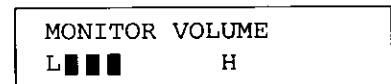

To lower the volume level:

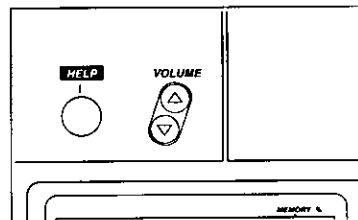

Press ∇ .

- Each press of ∇ decreases one black square mark on the display.

When using the handset:

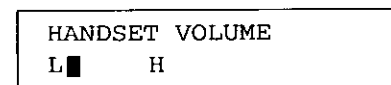

When using on-hook dialing:

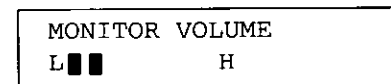

NOTE:

- After hanging up, the selected volume level will be maintained.

If you misdial:

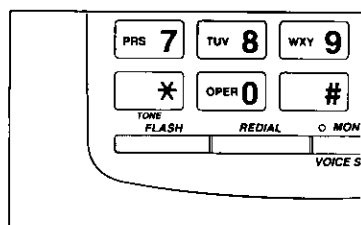

Press **FLASH** firmly before the other party answers.

The dial tone will sound, and dial the correct number.

Redialing the last dialed number

If the line is busy or you wish to redial the last dialed number, press the **REDIAL** button.

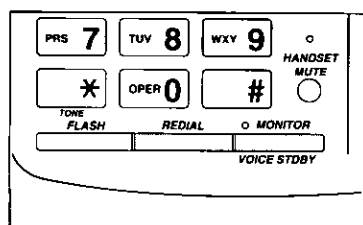

After pressing **MONITOR** or lifting the handset, press **REDIAL**.

<REDIALING>
1234567

NOTES:

- When using the handset, the unit redials the number once.
- When using on-hook dialing, the unit redials the number. If the line is busy, the unit will automatically redial the number. See the item number 8 on page 181. The **MONITOR** indicator light flashes and the following display is shown while waiting for the redialing.

AUG10 3:00PM 00
WAITING TO REDIAL

- To cancel the redialing, press the **STOP/CLEAR** button.

Answering voice calls

1. When the phone rings, lift the handset to answer the call.
2. When finished, replace the handset on the cradle.

Chapter 3

Advanced Instructions

Contents

	Page		Page
Storing Phone Numbers for		Network Communication	96
Automatic Dialer	58	Using the network passcode	96
Filling in the directory card	58	Programming the network passcode	98
Storing phone numbers for		Turning on the transmission passcode	
one-touch dialing	59	check mode	99
Storing multistations for one-touch dialing	61	Turning on the reception passcode	
Storing phone numbers for speed dialing	63	check mode	100
Storing secret phone numbers	65	Forwarding Received Documents	101
Erasing Stored Phone Numbers	67	Fax forwarding report	103
Printing Stored Phone Number List	70	Retrieving mis-forwarded documents	104
Printing the telephone number list	71	Turning on or off the forwarding feature	
Electronic Telephone Directory	72	from a remote location	104
Before using the electronic telephone		Using the TRANSMIT SETTING Button	106
directory	72	Total page number and the special	
How to use the electronic telephone		message	106
directory	73	Overseas transmission mode	107
Facsimile		Transmitting documents with the	
Transmitting Documents Using		TRANSMIT SETTING button	107
Automatic Dialer	75	Programming a personal message	109
Using one-touch dialing	75	<i>Telephone</i>	
Using the broadcast keys	76	Making Voice Calls Using	
Using speed dialing	77	Automatic Dialer	111
Using the electronic telephone directory	78	Making voice calls using the electronic	
Reserving Transmission		telephone directory	112
while Receiving Documents	80	Voice Contact	113
Delayed Transmission	81	Initiating voice contact	113
Polling	85	Receiving a request for voice contact	114
Polling another machine	85	TONE, FLASH, PAUSE, and MUTE	
Being polled	86	Buttons	115
Programming the polling passcode	88	Changing from pulse to tone mode	
Multistation Transmission	90	(TONE button)	115
Multitransmission report	92	Accessing features of your host	
Memory Transmission	93	exchange (FLASH button)	115
Setting the memory transmission	93	Inserting a pause into a phone number	
Transmitting the stored documents	94	(PAUSE button)	116
		Voice muting (HANDSET MUTE button)	117
		<i>Reserve Phone</i>	
		Reserve Phone	118

Storing Phone Numbers for Automatic Dialer

The unit's memory allows you to use both one-touch dialing (up to 30 phone numbers) and speed dialing (up to 100 phone numbers) for rapid access to the most frequently dialed numbers.

HELPFUL HINT:

- If you lose your instructions while programming, press the HELP button. The unit will print information on how to program.

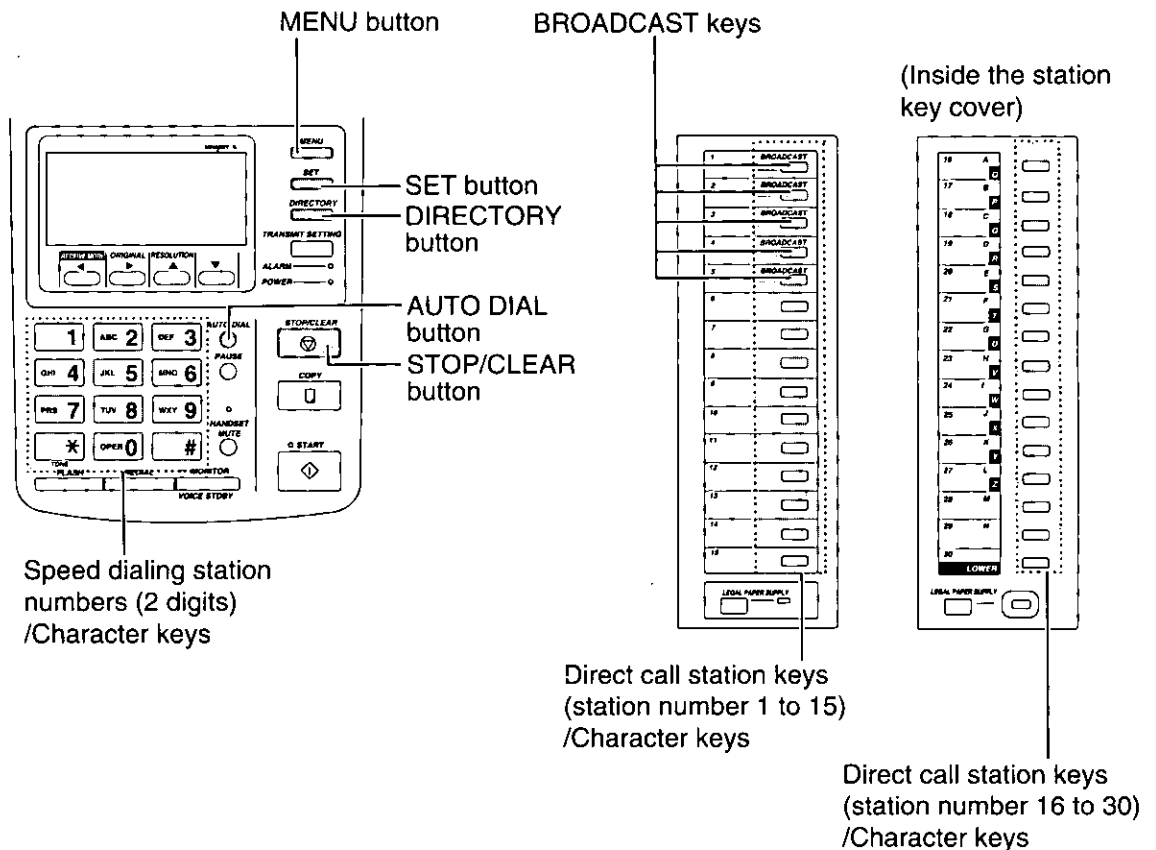

Filling in the directory card

1. Remove the clear cover using an instrument with a pointed end, like a pin or pen, as shown below.
2. Remove the directory card.
3. Write in the names associated with the direct call station keys.
 - To write in the names of the direct call station number 16 to 30, open the station key cover.
4. Re-install the directory card and the cover.

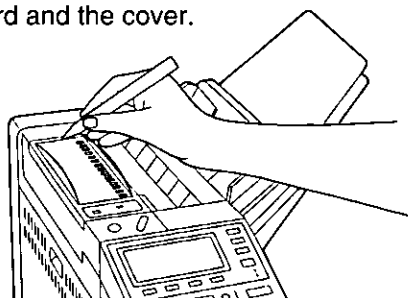

Storing phone numbers for one-touch dialing

You can store up to 30 telephone numbers and station names into the direct call station keys consisting of the upper stations (station numbers 1 to 15) and the lower stations (station numbers 16 to 30).

Each phone number can be programmed up to 30 digits in length.

Each station name can be programmed up to 16 characters.

The stored telephone numbers and names are also automatically stored in the electronic telephone directory (see page 72).

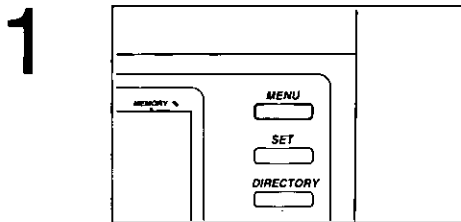

Press **MENU** until the following is shown.

PROG. [1.DATE 2.TEL
3.SYSTEM 4.REPORT]

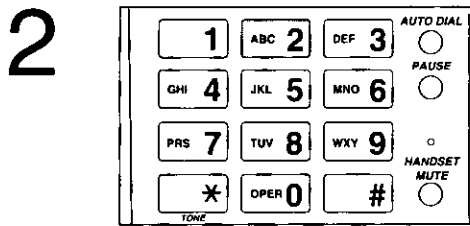

Press **2** to start programming.

SELECT AUTO OR
DIRECT CALL KEY

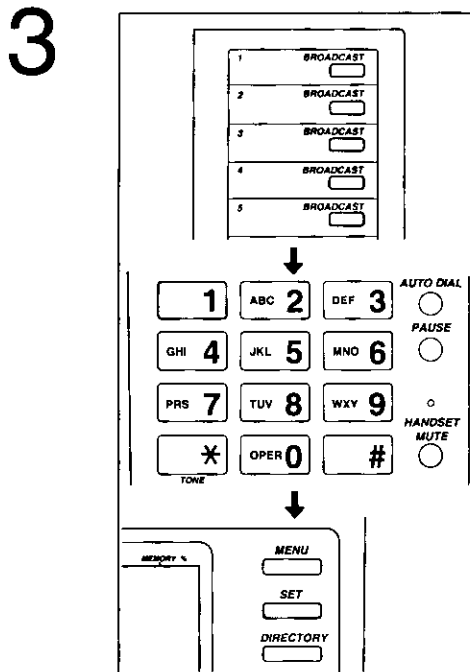

Press one of the direct call station keys where you want to store the phone number.

■ **When using the station numbers 1 to 5:**

1. Press the desired **BROADCAST** (1 to 5).

Example: The station number is 1.

BRDCAST.1 MODE=DIAL
[1.DIAL 2.PROG.]

2. Press 1.

– If you wish to store the multistation into **BROADCAST**, press **2** instead of **1** (see page 61).

3. Press **SET**.

ENTER TEL NO.<S01>
=

or

(continued)

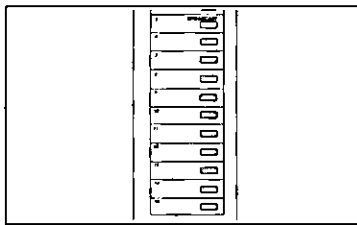

or

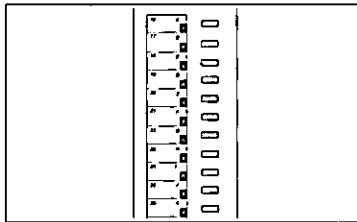

■ When using the upper station numbers 6 to 15:

Press the direct call station key (6 to 15)

Example: The station number is 6.

```
ENTER TEL NO.<S06>
=
```

or

■ When using the lower station numbers 16 to 30:

Open the station key cover, then press the direct call station key (16 to 30).

Example: The station number is 16.

```
ENTER TEL NO.<S16>
=
```

4

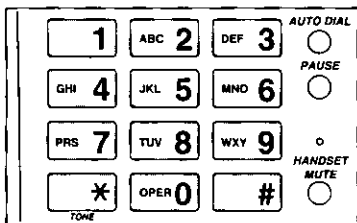

Enter the phone number.

Example: The station number is 6, and the phone number is 7654321.

```
ENTER TEL NO.<S06>
=7654321
```

- To insert a hyphen into the number, close the station key cover and press **HYPHEN** (direct call station "10") while entering the number.
- HYPHEN is counted as 2 digits.

5

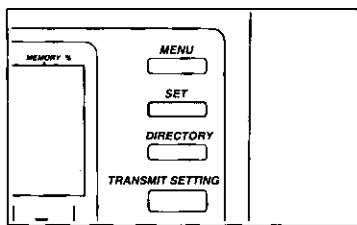

Press **SET** to store the program into memory.

```
ENTER NAME
=
```

6

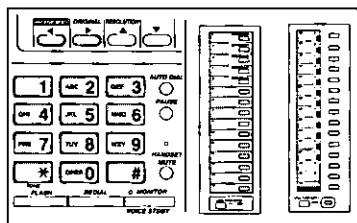

Enter the name associated with the direct call station by using the dial keypad and the direct call station keys as character keys, and the cursor key (◀ or ▶).

- For further details of the character keys, see page 37.

7

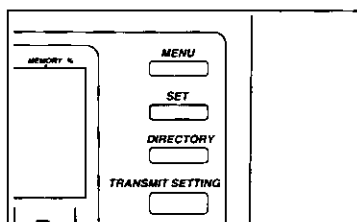

Press **SET** to store the program into memory.

```
SELECT AUTO OR
DIRECT CALL KEY
```

- To store other phone numbers, repeat steps 3 through 7.

(continued)

8

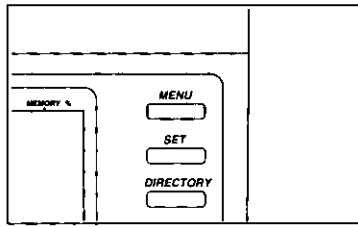

After storing the numbers, press **MENU** to end the operation.

– To transmit documents by one-touch dialing, see page 75.

NOTES:

- To correct an error while programming before pressing the SET button, press the STOP/CLEAR button, then try again.
- To cancel the programming halfway, press the MENU button.
- You can confirm that you have correctly stored phone numbers with the telephone number list (see page 70).

HELPFUL HINT for overseas transmission:

- When storing the phone number, add two pauses at the end of the number by pressing the PAUSE button (see page 116).

Storing multistations for one-touch dialing

The unit has 5 BROADCAST keys. Each key is used to program and store more than one station (multistation transmission), as well as a phone number in a direct call station key. This is very useful when frequently sending the same documents to fixed parties.

If you store the phone number by using a full number, only one station will be acceptable. So, before you start programming, make sure that the desired phone numbers have been stored into the direct call stations or speed dial stations (see pages 59 and 63).

The BROADCAST keys can also be used as the direct call station keys 1 to 5, but they cannot be used for two purposes. For example, if the direct call station number 1 has already been used for a phone number, it cannot be used as the broadcast number 1.

1

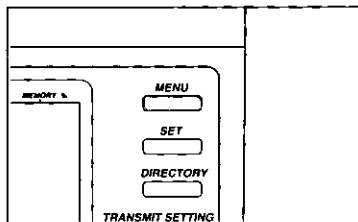

Press **MENU** until the following is shown.

```

  PROG. [1.DATE 2.TEL
         3.SYSTEM 4.REPORT]
  
```

2

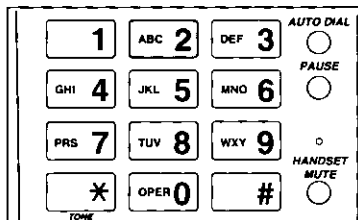

Press 2 to start programming.

```

  SELECT AUTO OR
  DIRECT CALL KEY
  
```

(continued)

3

3

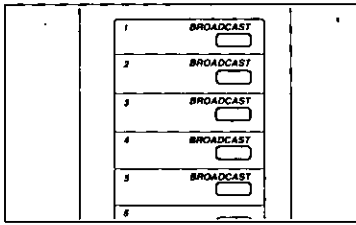

Press the desired **BROADCAST** (1 to 5).

Example: The broadcast number is 1.

```
BRDCAST.1 MODE=DIAL
[1.DIAL 2.PROG.]
```

4

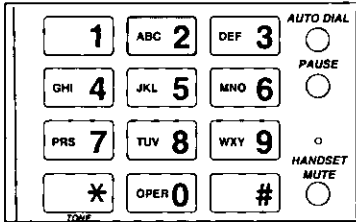

Press **2**.

```
BRDCAST.1 MODE=PROG
[1.DIAL 2.PROG.]
```

- If you use this key as a direct call station key, press **1** instead of **2**. See page 59.

5

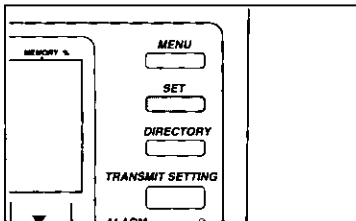

Press **SET** to store your selection into memory.

```
ENTER PHONE NUMBER
= [001]
```

6

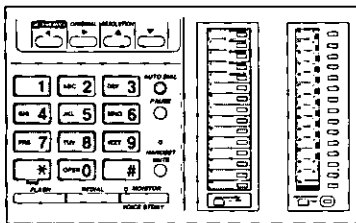

Enter the phone number by using the direct call station key or the speed dial station.

Example: The phone number is the direct call station 6.

```
ENTER PHONE NUMBER
=<S06> [001]
```

NOTE:

- When entering the phone number by using a full number, only one station will be acceptable.

7

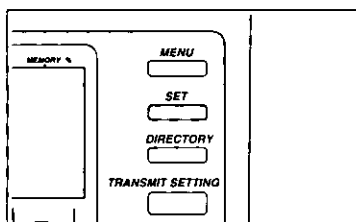

Press **SET** to store the number into memory.

```
ENTER PHONE NUMBER
= [002]
```

- To enter other phone numbers, repeat steps 6 and 7 (up to 129 stations).

8

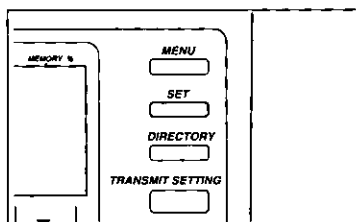

Press **SET** again after entering all the desired phone numbers.

```
SELECT AUTO OR
DIRECT CALL KEY
```

(continued)

9

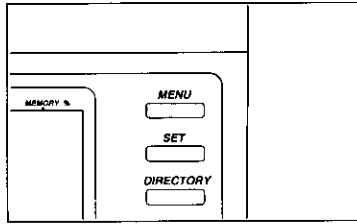

Press **MENU** to end the operation.

– To transmit documents by using **BROADCAST**, see page 76.

NOTES:

- To correct an error while programming, press the STOP/CLEAR button, then try again.
- To cancel the programming halfway, press the MENU button.
- You can confirm that you have correctly stored your programming with the telephone number list (see page 70).

Storing phone numbers for speed dialing

The unit is equipped with 100 stations (00 to 99) for speed dialing, each of which can store a phone number and a station name .

Each phone number can be programmed up to 30 digits in length.

Each station name can be programmed up to 16 characters.

The stored telephone numbers and names are also automatically stored in the electronic telephone directory (see page 72).

1

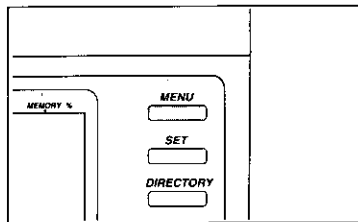

Press **MENU** until the following is shown.

PROG. [1.DATE 2.TEL
3.SYSTEM 4.REPORT]

2

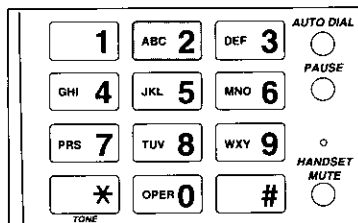

Press **2** to start programming.

SELECT AUTO OR
DIRECT CALL KEY

3

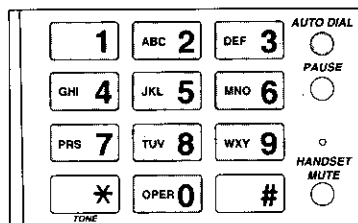

Press **AUTO DIAL**.

Then enter the 2-digit number (00 to 99).

Example: The station number is 00.

ENTER TEL NO.<A00>
=

(continued)

3

4

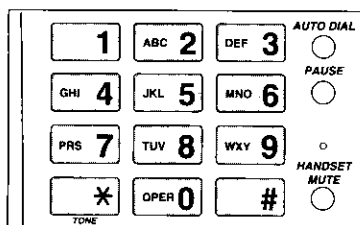

Enter the phone number.

Example: The phone number is 1234567.

```
ENTER TEL NO.<A00>
=1234567
```

- To insert a hyphen into the number, press **HYPHEN** (direct call station "10") while entering the number.
- HYPHEN is counted as 2 digits.

5

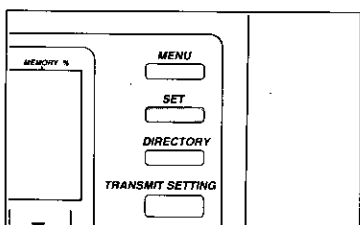

Press **SET** to store the program into memory.

```
ENTER NAME
=
```

6

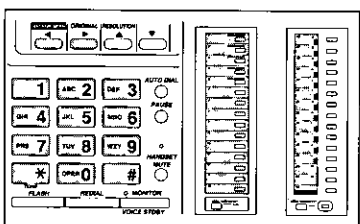

Enter the name associated with the speed dial station by using the dial keypad and the direct call station keys as character keys, and the cursor key (◀ or ▶).

- For further details of the character keys, see page 37.

7

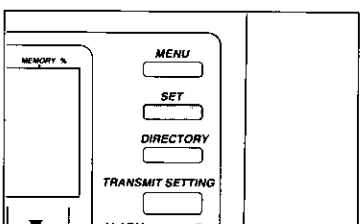

Press **SET** to store the program into memory.

```
SELECT AUTO OR
DIRECT CALL KEY
```

- To store other phone numbers, repeat steps 3 through 7.

8

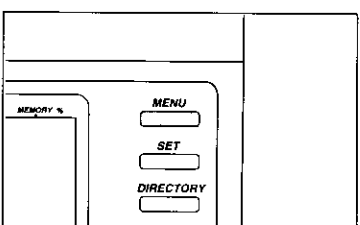

After storing the numbers, press **MENU** to end the operation.

- To transmit documents by speed dialing, see page 77.

NOTES:

- To correct an error while programming before pressing the SET button, press the STOP/CLEAR button, then try again.
- To cancel the programming halfway, press the MENU button.
- You can confirm that you have correctly stored phone numbers with the telephone number list (see page 70).

HELPFUL HINT for overseas transmission:

- When storing the phone number, add two pauses at the end of the number by pressing the PAUSE button (see page 116).

Storing secret phone numbers

This function is useful for keeping a whole phone number or a portion of a phone number secret. When a list of the stored numbers is printed, secret numbers will not be printed.

The stored telephone numbers and names are also automatically stored into the electronic telephone directory (see page 72).

1

Proceed with steps 1 through 3 on page 59 for one-touch dialing or on page 63 for speed dialing.

Example: The direct call station key 7 is selected.

```
ENTER TEL NO.<S07>
=
```

2

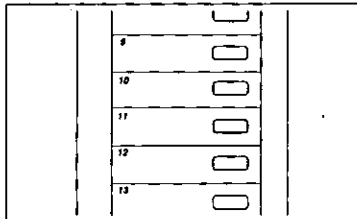

Press **SECRET** (direct call station "11") at the beginning of the number which you want to keep secret, then enter the number.

Example: 9876543 is a secret number.

"[" is displayed representing the start position of the secret number.

```
ENTER TEL NO.<S07>
=[9876543
```

– Pressing **SECRET** once counts as 2 digits.

3

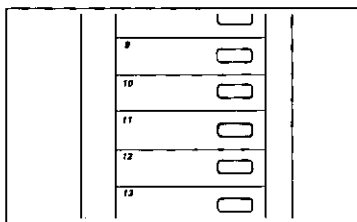

Press **SECRET** at the end of the number.

"]" is displayed representing the ending position of the secret number.

```
ENTER TEL NO.<S07>
=[9876543]
```

4

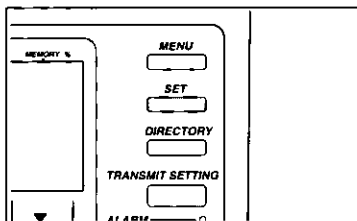

Press **SET** to store the number into memory.

```
ENTER NAME
=
```

(continued)

3

5

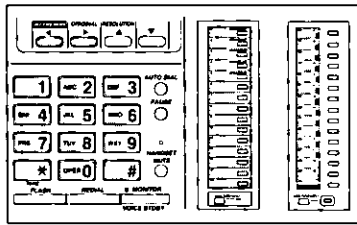

Enter the station name by using the dial keypad and the direct call station keys as character keys, and the cursor key (◀ or ▶).

– For further details of the character keys, see page 37.

6

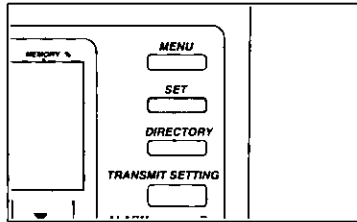

Press **SET** to store the program into memory.

SELECT AUTO OR
DIRECT CALL KEY

7

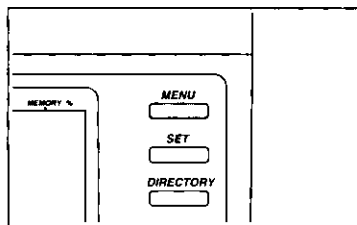

Press **MENU** to end the operation.

NOTES:

- To correct an error while programming before pressing the SET button, press the STOP/CLEAR button, then try again.
- To cancel the programming halfway, press the MENU button.

Erasing Stored Phone Numbers

You may erase the stored phone numbers in the direct call station keys and speed dial stations.

The erased telephone number and station name are also automatically erased from the electronic telephone directory.

1

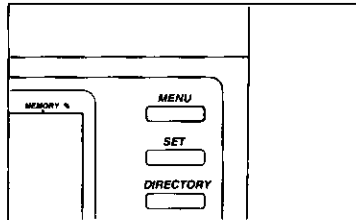

Press **MENU** until the following is shown.

PROG. [1.DATE 2.TEL
3.SYSTEM 4.REPORT]

2

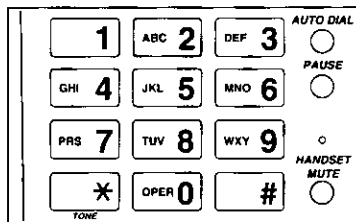

Press **2** to start programming.

SELECT AUTO OR
DIRECT CALL KEY

3

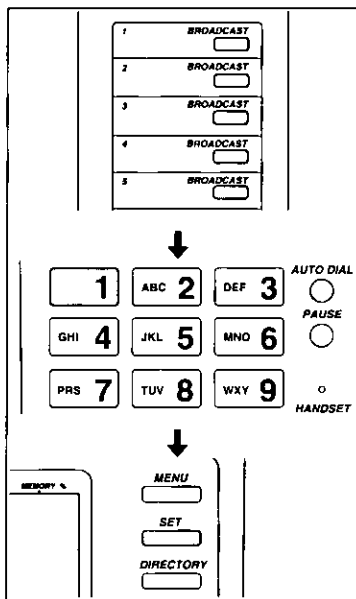

■ **Erasing the phone number in the direct call station numbers 1 to 5 (broadcast keys 1 to 5):**

1. Press the desired **BROADCAST** (1 to 5).

Example: The broadcast number is 2.

BRDCAST.2 MODE=DIAL
[1.DIAL 2.PROG.]

2. Press **1**.

3. Press **SET**.

The display shows the stored phone number.

NOTE:

- If you have stored the multistation into the selected broadcast number, the display will not show the number. Skip step 4 and go to step 5.

or

or

(continued)

3

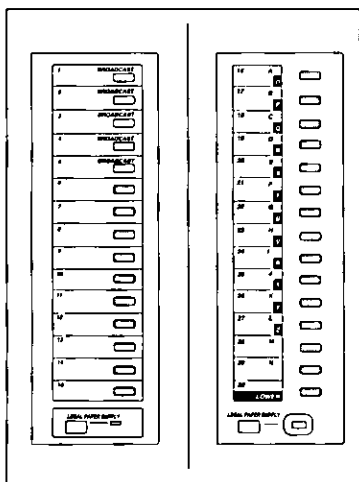

■ **Erasing the phone number in the direct call station numbers 6 to 30:**

Press the direct call station key.

- To erase the station numbers 16 to 30, open the station key cover and press the direct call station key.

The display shows the stored phone number.

or

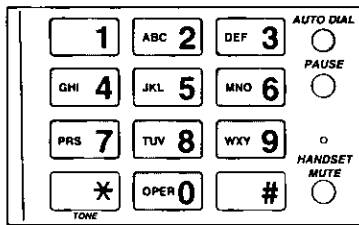

or

■ **Erasing the phone number in the speed dial station:**

Press **AUTO DIAL** and then enter the desired 2-digit number (00 to 99).

The display shows the stored phone number.

4

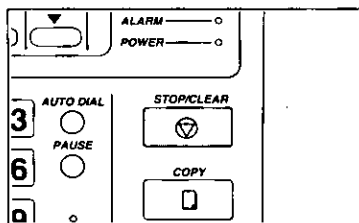

Press **STOP/CLEAR** to delete the phone number.

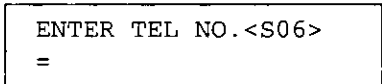

5

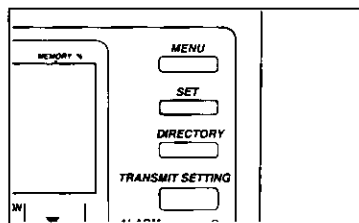

Press **SET**.

The display shows the stored station name.

- If a broadcast number is selected at step 3 into which the multistation has been stored, the display will not show the station name. Skip step 6 and go to step 7.

6

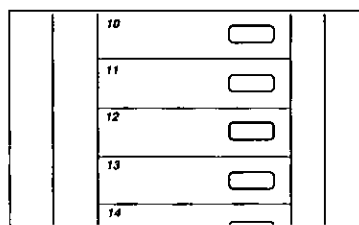

Press **DISPLAY CLEAR** (direct call station "12") to delete the station name.

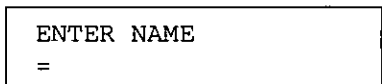

(continued)

7

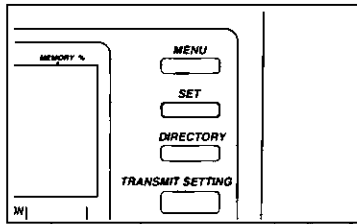

Press **SET** to erase the phone number and the station name from memory.

SELECT AUTO OR
DIRECT CALL KEY

– To erase other phone numbers, repeat step 3 through 7.

8

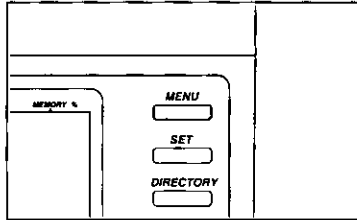

After erasing the numbers, press **MENU** to end the operation.

NOTE:

– To cancel the programming halfway, press the MENU button. The phone number and the station name will remain in memory.

3

Printing Stored Phone Number List

The unit can print a list of the numbers programmed for one-touch dialing and speed dialing. The list will print in two pages. Use this feature to confirm correctly stored phone numbers.

Sample of the telephone number list:

```

***** TELEPHONE NUMBER LIST *****
<< AUTO KEY LIST >>
-----
PHONE NUMBER      NAME      PHONE NUMBER      NAME
00
01
02
03
04
05
06
07
08
09
10
50
51
52
53
54
55
56
57
58
59
60
    
```

```

***** TELEPHONE NUMBER LIST *****
<< BROADCAST KEY LIST >>

* BROADCAST 1 *
  01 KEY MODE      = PROGRAM
  02 PHONE NUMBER  = S06,S10,A00

* BROADCAST 2 *
  01 KEY MODE      = DIAL
  02 PHONE NUMBER  =
  03 NAME          =

* BROADCAST 3 *
  01 KEY MODE      = DIAL
  02 PHONE NUMBER  =
  03 NAME          =

* BROADCAST 4 *
  01 KEY MODE      = DIAL
  02 PHONE NUMBER  =
  03 NAME          =

* BROADCAST 5 *
  01 KEY MODE      = DIAL
  02 PHONE NUMBER  =
  03 NAME          =

<< STATION KEY LIST >>
-----
PHONE NUMBER      NAME      PHONE NUMBER      NAME
06 R7654321
07 R[ ]
08 T5551234
09 R9P0925554433
10 R2345678
11
12
13
14
19 MAIN OFFICE
20 MARY
21 Panasonic
22 DEF Company
23 WEST BRANCH
24
25
26
27
    
```

Codes in each phone number:

- T: The telephone number has been entered in the tone dialing mode.
- R: The telephone number has been entered in the pulse (rotary) dialing mode.
- P: The pause has been entered.
- F: The flash has been entered.
- : The hyphen has been entered.
- []: The secret phone number has been entered. (The telephone number is not printed.)

Printing the telephone number list

1

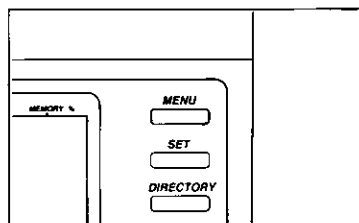

Press **MENU** until the following is shown.

PROG. [1.DATE 2.TEL
3.SYSTEM 4.REPORT]

2



Press **4** to activate the printing function.

SELECT NO. [1.SYSTEM
2.TEL NO. 3.JOURNAL]

3

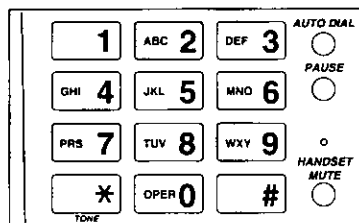

Press **2** to print the telephone number list.

The unit starts printing.

PRINTING PHONE LIST

4

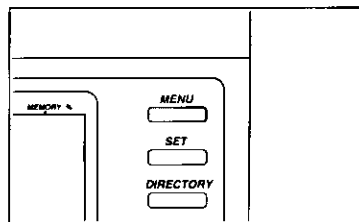

After printing, press **MENU** to end the operation.

NOTE:

– To stop printing, press the STOP/CLEAR button until a beep is heard.

3

Electronic Telephone Directory

Before using the electronic telephone directory

The telephone numbers and their associated names, stored for the automatic dialer, are automatically registered in the electronic telephone directory in alphabetical order. You can transmit a document or make a voice call by selecting the desired name from the electronic telephone directory. This is useful when you have forgotten the station number of the party you wish to call.

See pages 58 to 66 for storing phone numbers.

Stored data (example)

One-touch dialing

ENTER TEL NO.<S06> =7654321
ENTER NAME =MAIN OFFICE

ENTER TEL NO.<S10> =2345678
ENTER NAME =WEST BRANCH

Speed dialing

ENTER TEL NO.<A00> =1234567
ENTER NAME =Anthony

ENTER TEL NO.<A50> =8765432
ENTER NAME =Judy

ENTER TEL NO.<A72> =5432109
ENTER NAME =Margaret

Secret phone number for one-touch dialing

ENTER TEL NO.<S07> =[9876543]
ENTER NAME =MARY

Electronic telephone directory

Stored names are registered in alphabetical order.

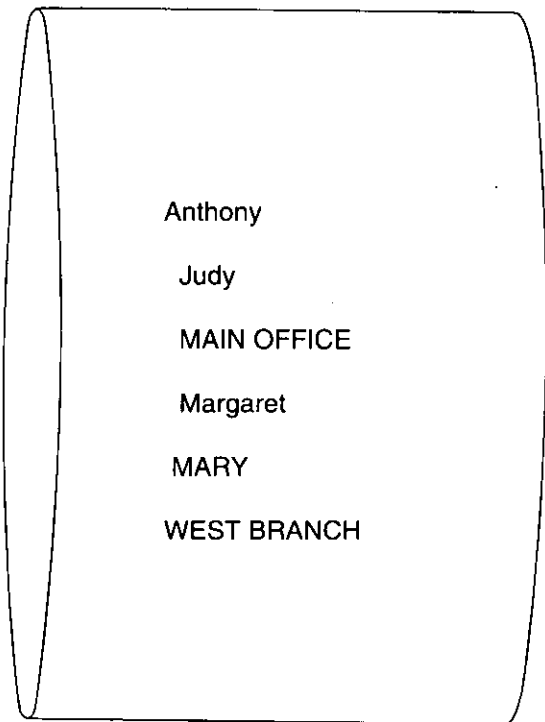

NOTES:

- Be sure to enter the names with the stored phone numbers before using the electronic telephone directory.
- To transmit documents by using the electronic telephone directory, see page 78.
- To make voice calls by using the electronic telephone directory, see page 112.

How to use the electronic telephone directory

HELPFUL HINT:

- If you lose your instructions while operating, press the HELP button.
- The unit will print information on how to operate.

Example: You call "MARY" whose number is stored into memory associated with the direct call station 7.

1

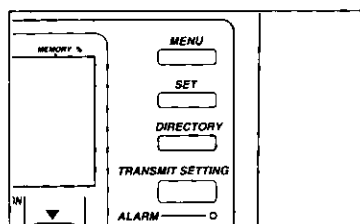

Press **DIRECTORY**.

SELECT INDEX
A-Z, 0-9, #

2

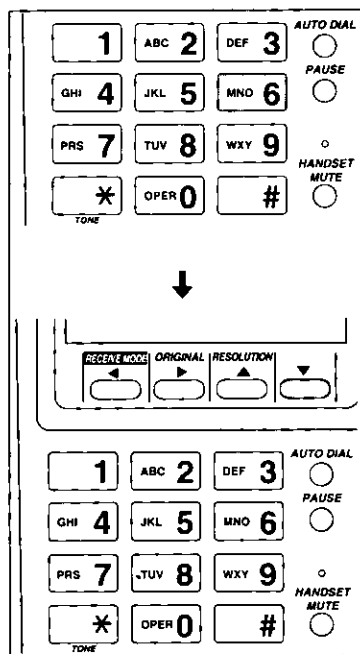

■ To access the desired index directly:

Press **6** to select "M".

OR

Open the station key cover and then press the direct call station number 28 to select "M".

The display shows the first name with the initial "M".

SELECT NAME <S06>
=MAIN OFFICE

Station number
<AXX> ... Speed dialing
<SXX> ... One-touch dialing

Then press ▼ repeatedly until "MARY" is displayed.

SELECT NAME <S07>
=MARY

OR

OR

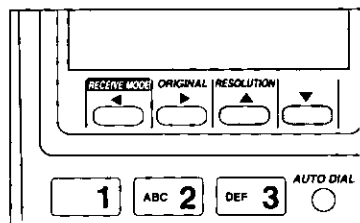

■ To look up the desired name in alphabetical order:

Press ▼ or ▲ repeatedly until the desired name is displayed.

The display shows the name in alphabetical order.

- Each press of ▼ shows the next name.
- Each press of ▲ shows the previous name.

(continued)

3

3

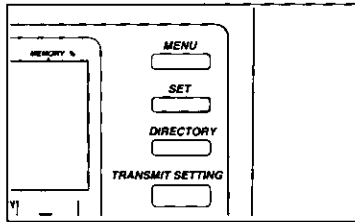

Press **SET** to start dialing.

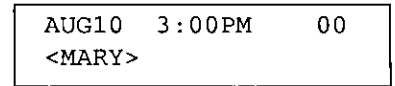

How to select an index:

To select the desired index, use the dial keypad and the direct call station numbers 16 to 30.

■ Dial keypad

Keypad: Index:

11
GHI 4G H I 4
PRS 7P Q R S 7
*(not assigned)

Keypad: Index:

ABC 2A B C 2
JKL 5J K L 5
TUV 8T U V 8
OPER 00

Keypad: Index:

DEF 3D E F 3
MNO 6M N O 6
WXY 9W X Y Z 9
#Others

Example: To select index "B", press 2 twice.

■ Direct call station keys

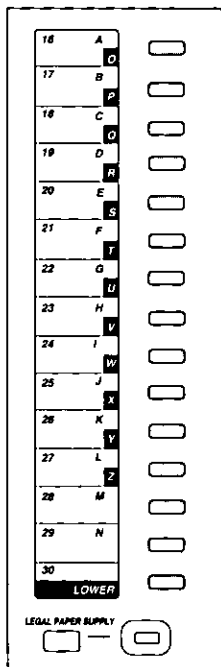

Open the station key cover. You can select the desired index by pressing the direct call station key that is corresponding to the index.

– The highlighted characters in each lower position can be selected by pressing the corresponding key after pressing the LOWER key.

Example: To select index "T", press the LOWER key and then press the direct call station number 21.

Transmitting Documents Using Automatic Dialer

You can transmit documents automatically by using one-touch dialing (including the BROADCAST keys) and speed dialing. Before using these features, make sure that the desired telephone numbers have been stored into memory. For storing phone numbers, see pages 58 to 66.

HELPFUL HINT:

- If you lose your instructions while operating, press the HELP button. The unit will print information on how to operate.

Using one-touch dialing

1

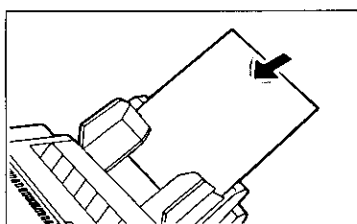

Insert the documents FACE DOWN.

- The unit can accept up to 20 pages at a time.

2

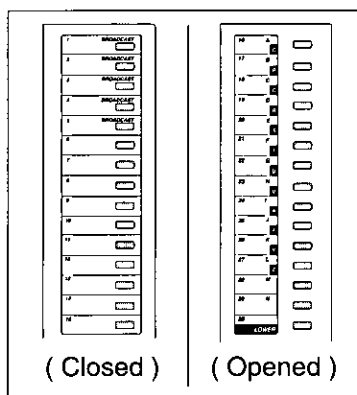

Press the desired direct call station key.

- When using the station numbers 16 to 30, open the station key cover and press the direct call station key.

The display shows the station name or station number, and the unit dials and transmits the documents automatically.

```
DIALING    <XMT>
TO : <XXXXXXXX>
```

Interrupting transmission:

- Press the STOP/CLEAR button until a beep sounds. To eject the document, press the STOP/CLEAR button again.

NOTES:

- If there is no answer or the line is busy, the unit will automatically redial the number. See item number 7 on page 181.
- To cancel redialing, press the STOP/CLEAR button.

3

Using the broadcast keys

The documents will be scanned and stored into memory when using the BROADCAST key. After transmission, the stored documents will be erased automatically.

– Concerning the memory capacity for storing documents, see page 7.

1

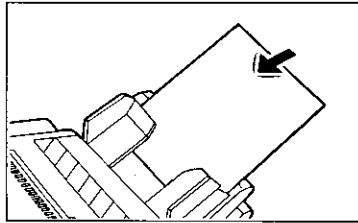

Insert the documents FACE DOWN.

2

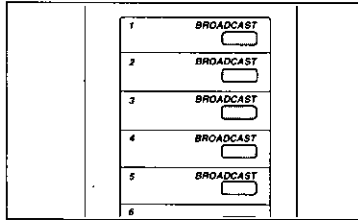

Press the desired **BROADCAST**.

The documents are fed into the unit and scanned into memory. And then the unit transmits the documents to each station, calling each number sequentially, one after another.

```
DIALING <MULTI XMT>
TO: <XXXXXXXXXX>
```

– The amount of memory used is shown as a percentage on the display.

```
AUG10 3:00PM XX
PAGES=XX
```

Interrupting transmission:

1. Press **STOP/CLEAR** twice.

```
CANCEL MULTI
XMT? [1.YES 2.NO]
```

2. Press 1.

The transmission will be interrupted and the stored documents will be erased from memory.

NOTES:

- Select the standard resolution when using the BROADCAST key. If you select the fine or halftone resolution, the number of documents that the unit can transmit will be decreased.
- A multitransmission report will be printed out after the transmission. This report will show the result. See page 92.
- If one of the stations is busy or does not answer, the station has been skipped, and the unit will automatically dial the next selected station. All skipped stations will be redialed after all other stations have been called. See item number 7 on page 181.

Using speed dialing

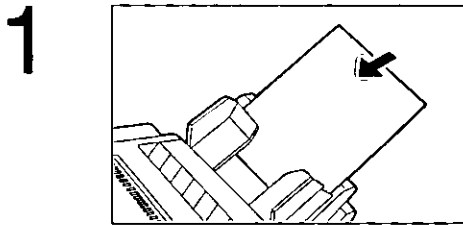

Insert the documents FACE DOWN.

– The unit can accept up to 20 pages at a time.

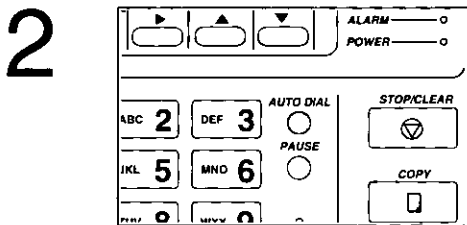

Press **AUTO DIAL**.

AUG10 3:00PM 00
<A

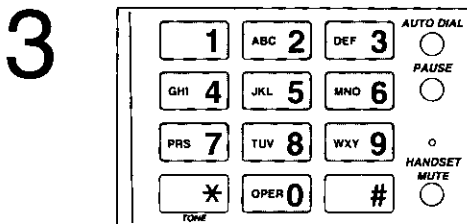

Enter the desired 2-digit number (00 to 99).

The display shows the station name or station number, and the unit dials and transmits the documents automatically.

DIALING <XMT>
TO: <XXXXXXXXXX>

Interrupting transmission:

– Press the STOP/CLEAR button until a beep sounds. To eject the document, press the STOP/CLEAR button again.

NOTES:

- If there is no answer or the line is busy, the unit will automatically redial the number. See item number 7 on page 181.
- To cancel redialing, press the STOP/CLEAR button.

3

Using the electronic telephone directory

You can transmit documents by selecting the desired name from the electronic telephone directory.

Make sure that the desired telephone numbers and their names have been stored into memory (see pages 58 to 66).

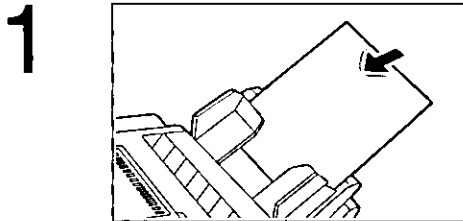

Insert the documents FACE DOWN.

– The unit can accept up to 20 pages at a time.

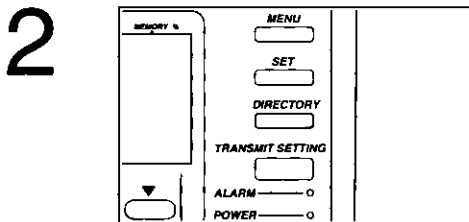

Press **DIRECTORY**.

SELECT INDEX
A-Z, 0-9, #

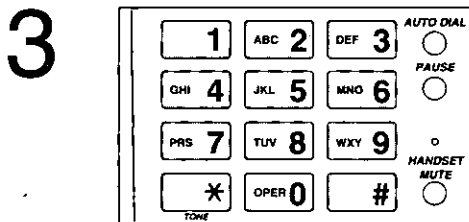

■ **To access the desired index directly:**
Enter the desired index (see page 74).

The first name in the index is displayed.

SELECT NAME <XXX>
=XXXXXXXXXX

OR

OR

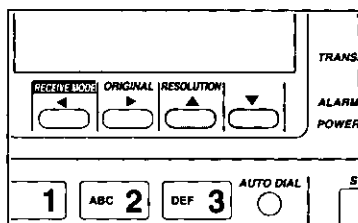

■ **To look up the desired name in alphabetical order:**

Press ▼ or ▲ until the desired name is shown.
Skip step 4 and go to step 5 on the next page.

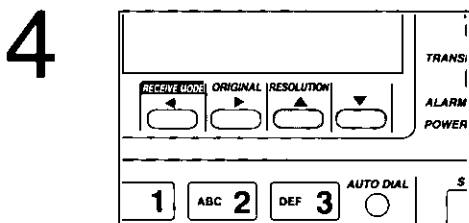

Press ▼ or ▲ until the desired name is shown.

– Use ▼ to advance the stored names, or ▲ to go back.

SELECT NAME <XXX>
=XXXXXXXXXX

(continued)

5

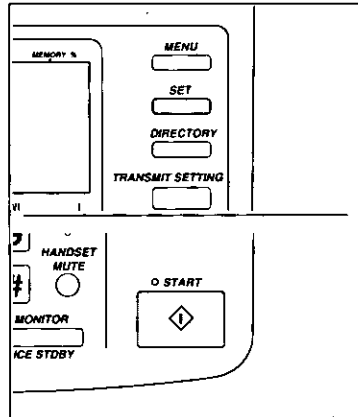

Press **SET** or **START**.

The unit dials and then transmits the documents automatically.

DIALING <XMT>
TO: <XXXXXXXXXX>

3

Interrupting transmission:

- Press the STOP/CLEAR button until a beep sounds. To eject the document, press the STOP/CLEAR button again.

Reserving Transmission while Receiving Documents

While the unit is receiving documents from one station, you can reserve transmission to another.

The unit will automatically scan and transmit documents after the fax reception.

HELPFUL HINT:

- If you lose your instructions while programming, press the HELP button. The unit will print information on how to program.

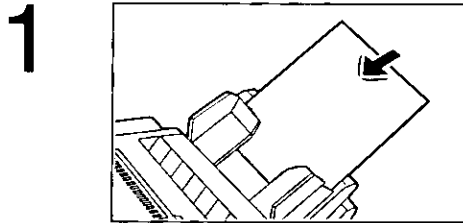

Insert the documents **FACE DOWN** during the fax reception.

- The unit can accept up to 20 pages at a time.

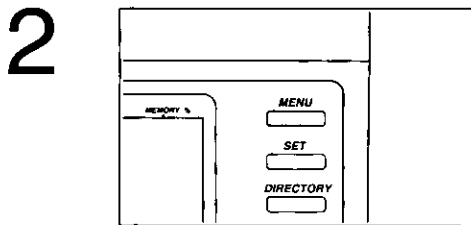
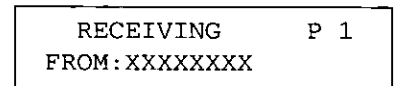

Press **MENU** until the following is shown.

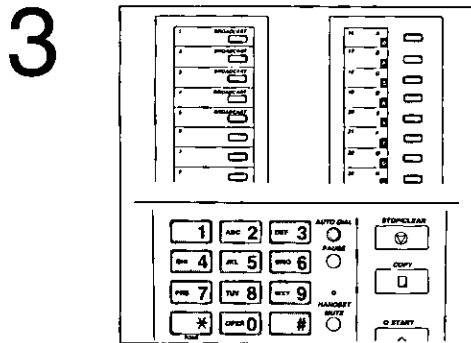

Enter the desired phone number by using the direct call station key, the speed dial station, or a full number.

Example: The direct call station 7 is dialed.



- If you have misdialed, press **STOP/CLEAR**, then enter the correct number.

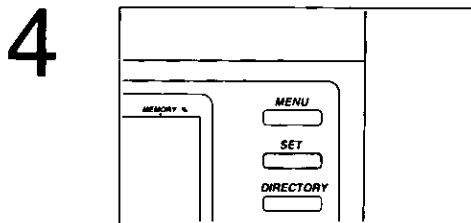

Press **SET** to set the reservation of transmission.

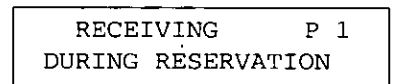

- The unit will automatically scan and transmit documents after reception has finished.

NOTES:

- You can use the electronic telephone directory (see page 73) when entering the phone number in step 3.
- To cancel the reservation, press the **STOP/CLEAR** button or remove the documents in the document feeder tray.

Delayed Transmission

By using a built-in clock, the unit can transmit documents automatically at a specific time. This allows you the opportunity to take advantage of low-cost calling hours that are offered by some telephone companies.

The delayed transmission can be reserved to take place up to 24 hours in advance.

There are two ways to transmit documents with this feature. One option is that the documents to be transmitted are scanned and stored into memory, and the unit starts transmission at a specific time (delayed memory transmission). After transmission, the stored documents will be erased automatically. The other option is that the documents are left in the document feeder tray.

– Concerning the memory capacity for storing documents, see page 7.

HELPFUL HINT:

– If you lose your instructions while programming, press the HELP button.
The unit will print information on how to program.

1

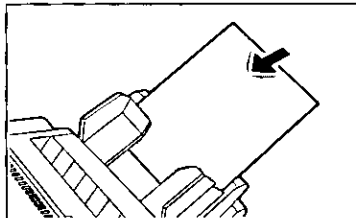

Insert the documents **FACE DOWN**.

– The unit can accept up to 20 pages at a time.

2

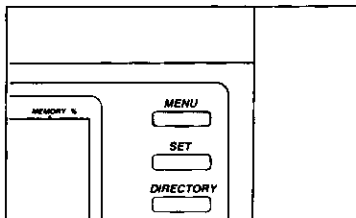

Press **MENU** until the following is shown.

```

DELATED XMT
=OFF  [1.ON 2.OFF]
    
```

3

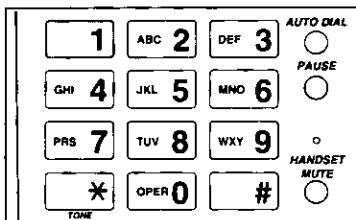

Press **1** to activate this feature.

```

DELATED XMT
=ON   [1.ON 2.OFF]
    
```

– If the delayed transmission is already set, the display will show the following:

```

OVERRIDE DELAYED
XMT ?  [1.YES 2.NO]
    
```

Press **1** to override the previous setting.

Press **2** to interrupt the procedure.

4

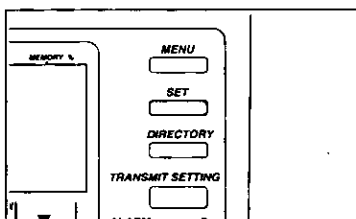

Press **SET** to store your selection into memory.

```

MEMORY. DELAYED XMT
=ON   [1.ON 2.OFF]
    
```

(continued)

5

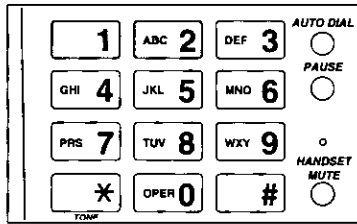

Enter the number of the selection you desire.

Setting selections:

- 1: ON (The delayed memory transmission will be activated.)
- 2: OFF (The delayed memory transmission will not be activated.)

6

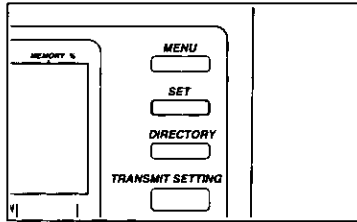

Press **SET** to store your selection into memory.

ENTER PHONE NUMBER
=

7

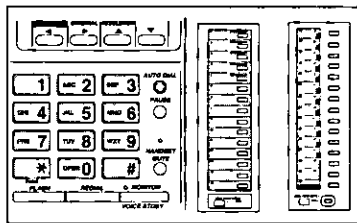

Enter the desired phone number by using the direct call station key, the speed dial station, or a full number.

Example: The direct call station 6 is dialed.

ENTER PHONE NUMBER
=<S06>

– If you have misdialed, press **STOP/CLEAR**, then enter the correct number.

8

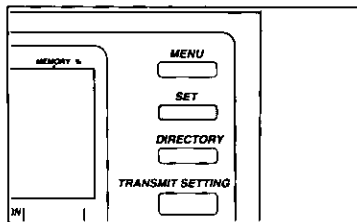

Press **SET** to store the number into memory.

SET START TIME
12:00AM [* =AM # =PM]

9

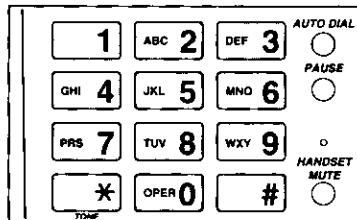

Enter the time of the start of transmission.

Example: If the starting time is 11:35PM, press 1135, then press #.

SET START TIME
11:35PM [* =AM # =PM]

- To select AM mode, press *.
- To correct an error, use the cursor key (◀ or ▶) to move the cursor to the incorrect number, then make the correction.

(continued)

10

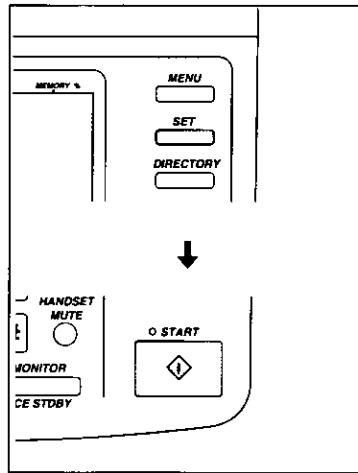

■ **When selecting the delayed memory transmission in step 5:**

1. Press **SET** to store the programming into memory.

PRESS
START KEY

2. Press **START**.

The documents are fed into the unit and scanned into memory.

- The amount of memory used is shown as a percentage on the display.

AUG10 3:00PM XX
PAGES=XX

The delayed memory transmission will be set after scanning the documents.

AUG10 3:03PM 30
XMT AT 11:35PM

OR

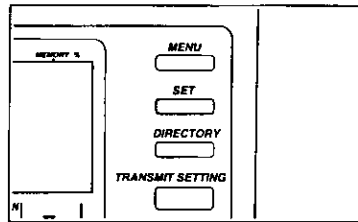

OR

■ **When not selecting the delayed memory transmission in step 5:**

1. Press **SET** to store the programming into memory.

The delayed transmission will be set.

AUG10 3:00PM 00
XMT AT 11:35AM

11

When a specified time has been reached, the unit will automatically start transmitting the documents.

- After the transmission, the delayed transmission feature is automatically turned off.

3

NOTES:

- You can receive, transmit, and copy documents while the delayed transmission is set. Remove documents for the delayed transmission from the document feeder tray, and transmit or copy documents. When you have finished, replace the removed documents.
- Select the standard resolution when selecting the delayed memory transmission. Otherwise the number of documents that the unit can transmit will be decreased.
- If there is no answer or the line is busy, the unit will automatically redial the number. See item number 7 on page 181.
- To cancel redialing, press the STOP/CLEAR button.
- Only one delayed transmission can be programmed. If you program another delayed transmission, the previous one will be overridden.
- You can use the electronic telephone directory when entering the phone number in step 7 (see page 73).

To cancel the delayed transmission:

1

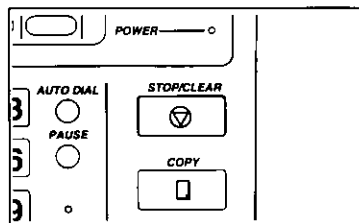

Press **STOP/CLEAR** after setting the delayed transmission.

CANCEL DELAYED
XMT? [1.YES 2.NO]

2

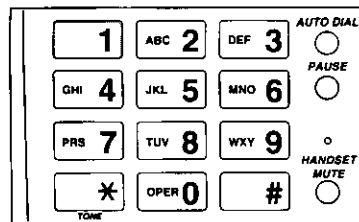

Press **1**.

The delayed transmission will be interrupted and the stored documents will be erased from memory.

- To continue the delayed transmission setting, press **2**.

Polling

“Polling” means that you call another facsimile machine (“polled machine”) to retrieve a document. The other party must be prepared for your call with a document loaded on the polled machine. This unit can both poll another facsimile machine and be polled. The machine initiating the call will incur any telephone charges.

Polling another machine

The following instructions allow for the polling of another station. Make sure that documents have not been fed into your unit and that documents to be transmitted are loaded on the polled machine.

HELPFUL HINT:

- If you lose your instructions while operating, press the HELP button. The unit will print information on how to operate.

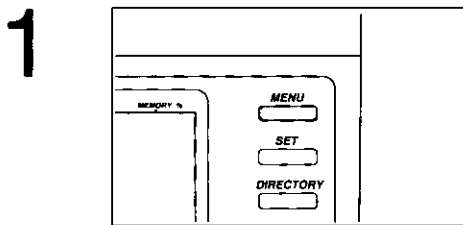

Press **MENU** until the following is shown.

POLLING
ENTER PHONE NUMBER

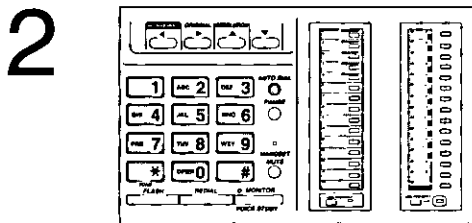

Enter the phone number of the unit you wish to poll by using the direct call station key, the speed dial station, or a full number.

Example: The direct call station 6 is dialed.

ENTER PHONE NUMBER
=<S06>

- If you have misdialed, press **STOP/CLEAR**, then enter the correct number.

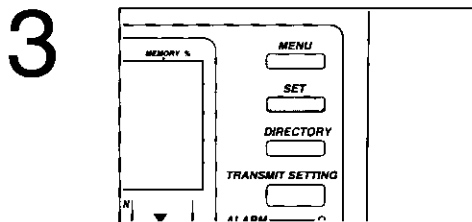

Press **SET** to store the phone number into memory.

PRESS
START KEY

(continued)

4

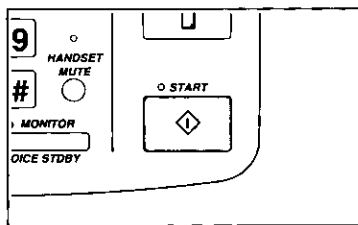

Press **START**.

The unit will automatically dial and receive documents from the polled machine.

DIALING <POLL>
TO: <S06>



POLLING P 1
FROM: XXXXXX

– After receiving documents, the polling function is automatically turned off.

NOTES:

- If the polled station is busy or there is no answer, the unit will automatically redial the number. See item number 7 on page 181.
- To cancel redialing, press the STOP/CLEAR button.
- You can use the electronic telephone directory when entering the phone number in step 2 (see page 73).

Being polled

In order to let other units poll your unit, your unit must hold the documents in memory. Your unit will transmit the stored documents when the other party has polled your unit. The stored documents will be kept in memory even after the transmission. The polled function can activate in the *TEL/FAX* or *FAX* mode.

The following instructions allow your unit to prepare to transmit the document when being polled.

- Concerning the memory capacity for storing documents, see page 7.

HELPFUL HINT:

- If you lose your instructions while operating, press the HELP button. The unit will print information on how to operate.

1

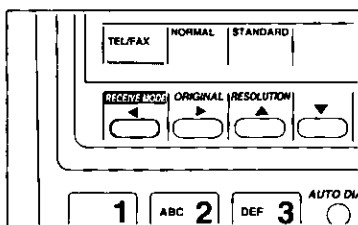

Set the receiving mode to the *TEL/FAX* or *FAX* mode.

(continued)

2

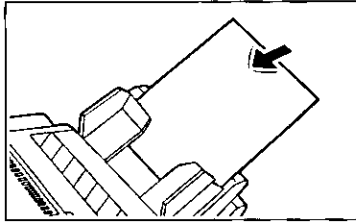

Insert the documents FACE DOWN.

3

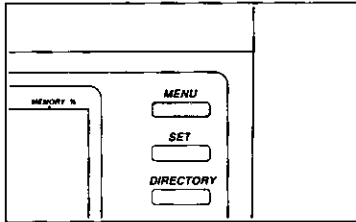

Press **MENU** until the following is shown.

```

POLLED ?
PRESS START KEY
  
```

4

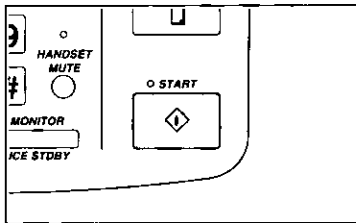

Press **START**.

The documents are fed into the unit and scanned into memory.

- The amount of memory used is shown as a percentage on the display.

```

AUG10  3:00PM  05
PAGES=01
  
```

- The "polled" function will be set after scanning the documents, and polling can begin.

```

AUG10  3:00PM  05
POLLED ON
  
```

- If you have already set the polled mode, the display will show the following:

```

OVERRIDE POLLED
MODE?  [1.YES 2.NO]
  
```

Press **1** to override the previous setting.
 Press **2** to interrupt the procedure.

NOTES:

- You can receive, transmit, and copy documents while the polled mode is set.
- Select the standard resolution when setting the polled mode. Otherwise the number of documents that the unit can transmit will be decreased.

3

To cancel the polled mode:

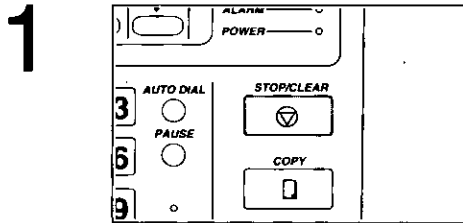

Press **STOP/CLEAR** after setting the polled mode.

CANCEL POLLED
MODE? [1.YES 2.NO]

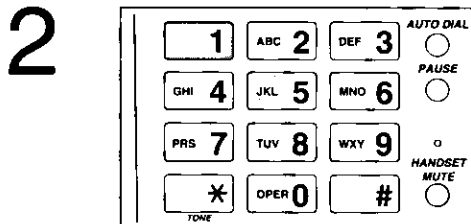

Press 1.

The polled mode will be interrupted and the stored documents will be erased from memory.

– To continue the polled mode, press 2.

Programming the polling passcode

To prevent an unauthorized machine from retrieving a document of a confidential nature, program a unique passcode in your unit. If the passcodes between the polling machine and polled machine do not match, a transmission will not take place. The polling passcode is pre-programmed to "0000", which will not activate the passcode check.

IMPORTANT:

– Polling using a passcode is effective between other compatible facsimile machines that have the same passcode. Concerning the compatibility, see page 7.

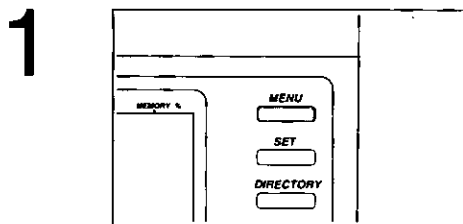

Press **MENU** until the following is shown.

PROG. [1.DATE 2.TEL
3.SYSTEM 4.REPORT]

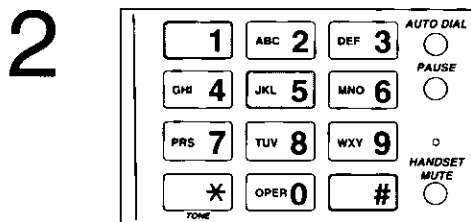

Press #, then press 15 to start programming.

POLLING PASSCODE
=0000

(continued)

3

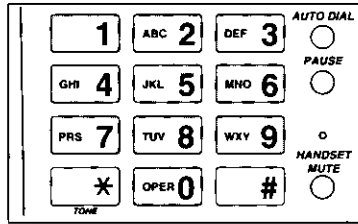

Enter the 4-digit polling passcode (choose from 0001 to 9999).

- To correct an error, use the cursor key (◀ or ▶) to move the cursor to the incorrect number, then make the correction.

4

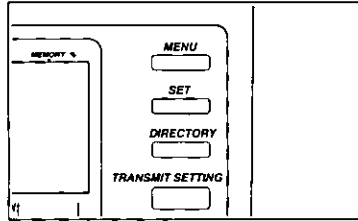

Press **SET** to store the program into memory.

PROG. [1.DATE 2.TEL
3.SYSTEM 4.REPORT]

5

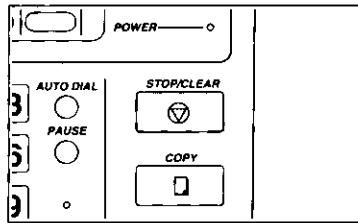

Press **STOP/CLEAR** to end the operation.

3

Multistation Transmission

By using the built-in memory, you can transmit documents up to 130 stations at a time. This saves the trouble of sending the same documents to each station in succession. Multistation transmission is performed by using the direct call stations or speed dial stations.

Before using this feature, make sure that the desired phone numbers have been stored into the direct call stations or speed dial stations (see pages 58 to 66).

When using this feature, the documents will be scanned and stored into memory first. After transmission to all stations, the stored documents will be automatically erased.

– Concerning the memory capacity for storing documents, see page 7.

HELPFUL HINT:

– If you lose your instructions while operating, press the HELP button. The unit will print information on how to operate.

1

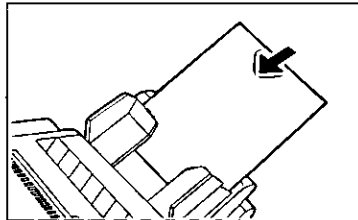

Insert the documents FACE DOWN.

2

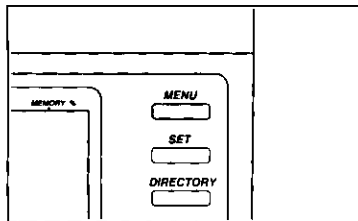

Press **MENU** until the following is shown.

```

MULTI XMT MODE
ENTER PHONE NUMBER
    
```

3

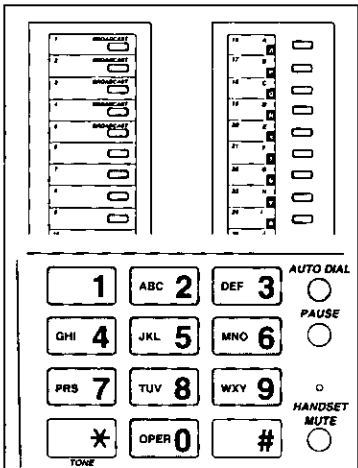

Enter the desired phone number by using the direct call station key or the speed dial station.

Example: The direct call station 8 is dialed.

```

ENTER PHONE NUMBER
=<S08>                [001]
    
```

- If you have misdialed, press **STOP/CLEAR**, then enter the correct number.
- When entering the phone number by using a full number, only one station will be acceptable.

(continued)

4

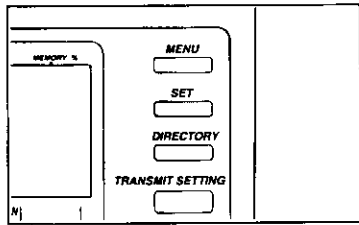

Press **SET** to store the number into memory.

```

ENTER PHONE NUMBER
=                      [002]
  
```

- To enter other numbers, repeat steps 3 and 4 (up to 130 stations).

5

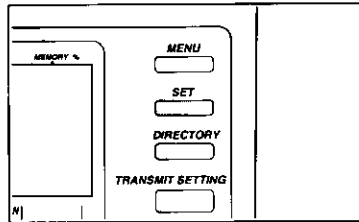

Press **SET** again after entering all the desired phone numbers.

```

PRESS
START KEY
  
```

6

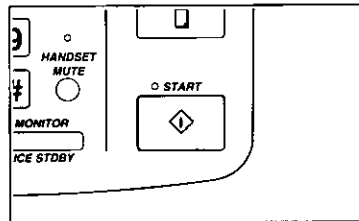

Press **START**.

The documents are fed into the unit and scanned into memory.

- The amount of memory used is shown as a percentage on the display.

```

AUG10  3:00PM   05
PAGES=01
  
```

- The unit then transmits the documents to each station, calling each number sequentially, one after another.

NOTES:

- Select the standard resolution when using a multistation transmission. Otherwise the number of documents that the unit can transmit will be decreased.
- If a station is busy or does not answer, the station has been skipped. The unit will automatically dial the next selected station. All skipped stations are redialed after all other stations have been called. See item number 7 on page 181. While waiting to redial, the following will be shown.

```

AUG10  3:00PM   05
MULTI XMT ON
  
```

- A multitransmission report will be printed out after all the transmissions have been completed. See page 92.
- You can use the electronic telephone directory when entering the phone number in step 3 (see page 73).

3

To cancel a multistation transmission:

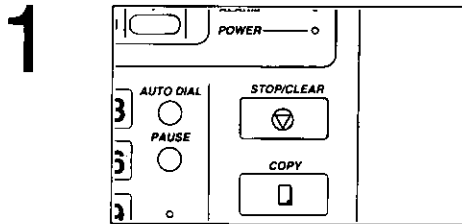

Press **STOP/CLEAR** twice after setting the multistation transmission.

CANCEL MULTI
XMT? [1.YES 2.NO]

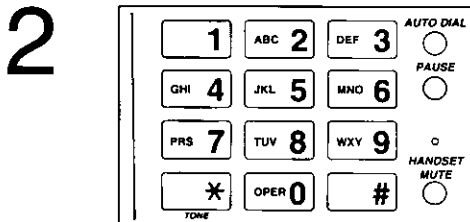

Press 1.

The multistation transmission will be interrupted and the stored documents will be erased from memory.

NOTES:

- A multitransmission report will be printed out.
- If you press the STOP/CLEAR button while dialing or transmitting, only the displayed transaction will be interrupted.

Multitransmission report

After all the transmissions have been completed, the unit will automatically print the following report:

Sample of the multitransmission report:

```

***** MULTI TRANSMISSION REPORT *****
*
*                                     AUG. 10. 1994   3:36PM
*
* No.   OTHER FACSIMILE      START TIME   USAGE TIME  TX PAGES  RESULT      *CODE
*-----*-----*-----*-----*-----*-----*-----*
* 001   MAIN OFFICE          AUG. 10  3:31PM  00'42    00        NO RESPONSE
* 002   MARY                  AUG. 10  3:33PM  00'41    00        NO RESPONSE
* 003   Quasar                AUG. 10  3:34PM  00'42    00        NO RESPONSE
* 004   Anthony               AUG. 10  3:35PM  00'41    00        NO RESPONSE
*-----*-----*-----*-----*-----*-----*
*                                     TOTAL          02'46    00
*
*                                     RESULT : NO RESPONSE
*                                     << POSSIBILITY OF REASON >>
*                                     1. RECEIVING FAX BUSY.
*                                     2. RECEIVING FAX OUT OF PAPER.
*                                     3. POWER FAILURE OR OTHERS.
*
*****

```

Memory Transmission

The unit will be able to scan and store the documents into memory, and the unit will transmit the stored documents.

The stored documents will be automatically erased after transmission.

– Concerning the memory capacity for storing documents, see page 7.

Setting the memory transmission

HELPFUL HINT:

– If you lose your instructions while programming, press the HELP button.

The unit will print information on how to program.

1

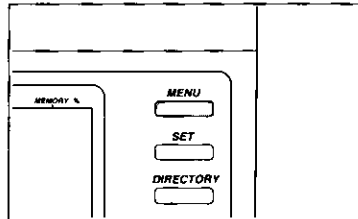

Press **MENU** until the following is shown.

```
PROG. [1.DATE 2.TEL
3.SYSTEM 4.REPORT]
```

2

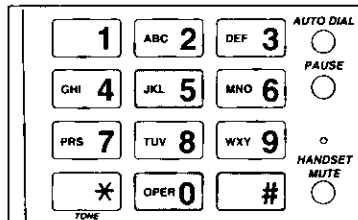

Press #, then press **05** to start programming.

```
MEMORY XMT
=OFF [1.ON 2.OFF]
```

3

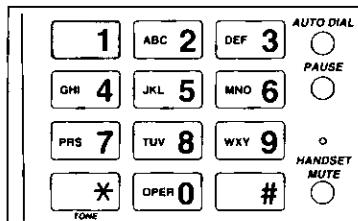

Press **1** to activate this feature.

```
MEMORY XMT
=ON [1.ON 2.OFF]
```

– To de-activate this feature, press **2**.

4

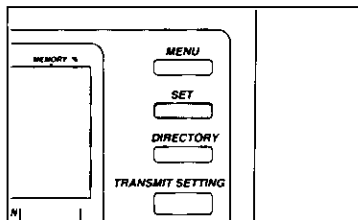

Press **SET** to store your selection into memory.

```
PROG. [1.DATE 2.TEL
3.SYSTEM 4.REPORT]
```

5

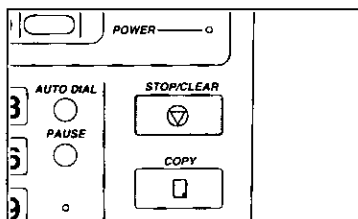

Press **STOP/CLEAR** to end the operation.

– The memory transmission function has been set.
– Go to page 94 to start transmission.

NOTES:

- Whenever you transmit the document by using the polled mode or multistation transmission, the memory transmission will be activated, regardless of whether it is set or not.
- Select the standard resolution when using the memory transmission. Otherwise the number of documents that can be stored into memory will be decreased.

Transmitting the stored documents

1

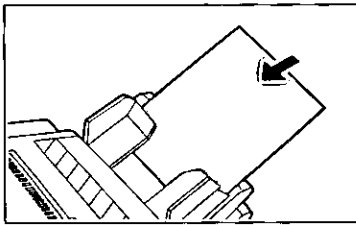

Insert the documents FACE DOWN.

2

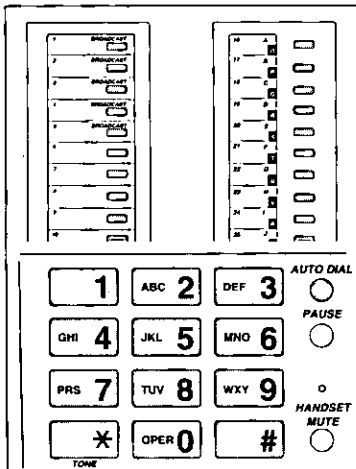

Enter the desired phone number by using the direct call station key, the speed dial station, or a full number.

- If you have misdialed, press **STOP/CLEAR**, then enter the correct number.
- Press **START** when entering a full number.

The documents are fed into the unit and scanned into memory.

After storing all pages, the unit transmits the documents.

- The amount of memory used is shown as a percentage on the display.

AUG10 3:00PM 05
PAGES=01

NOTES:

- If there is no answer or the line is busy, the unit will automatically redial the number. See item number 7 on page 181.
- To cancel redialing, press the **STOP/CLEAR** button.
- You can use the electronic telephone directory when entering the phone number in step 2 (see page 73).

To cancel the memory transmission:

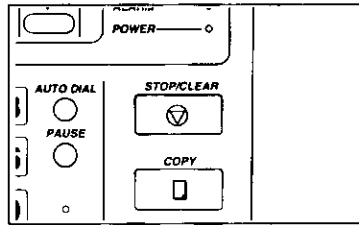

Press **STOP/CLEAR** while or after scanning documents.

The unit will stop the transmission, and the stored documents will be erased from memory.

AUG10 3:01PM 00
USER STOPPED

Network Communication

The network communication feature eliminates fax transmissions to unauthorized parties, and helps to prevent reception from unauthorized stations. This feature is effective in preventing "junk mail" faxes.

When the network communication feature is used, the identical network passcode of 4 digits must be programmed on both sides of the line. The unit checks the passcode before transmitting or receiving a document.

The unit provides two types of passcode check modes as below.

■ **Transmission passcode check mode:**

Activate this mode to restrict document transmission. If the passcode sent from the other machines does not match with the one programmed in your unit, transmission will not take place.

■ **Reception passcode check mode:**

Activate this mode to restrict document reception. If the passcode sent from the other machines does not match with the one programmed in your unit, reception will not take place.

IMPORTANT:

– These features are effective between other compatible facsimile machines that have the same passcode. Concerning the compatibility, see page 7.

NOTE:

– The passcode for the polling feature is not related to this network communication feature. They are independent features.

Using the network passcode

Before communication begins, check that your passcode and the other station's passcode are identical. See page 98 to program the passcode.

■ **To transmit a document to a designated station only:**

Set the transmission passcode check mode to on (see page 99).

Functions	Display indications	Your unit	Other compatible machine
Transmission passcode check mode	TX PASSCODE CHECK	ON	ON/OFF
Reception passcode check mode	RX PASSCODE CHECK	OFF	ON/OFF

Your unit transmits a document only when the correct passcode has been received.

■ **To receive a document from a designated station only:**

Set the reception passcode check mode to on (see page 100).

Functions	Display indications	Your unit	Other compatible machine
Transmission passcode check mode	TX PASSCODE CHECK	OFF	ON/OFF
Reception passcode check mode	RX PASSCODE CHECK	ON	ON/OFF

Your unit receives a document only when the correct passcode has been received.

■ **To transmit a document to and receive a document from a designated station:**

Set both the transmission and reception passcode check modes to on (see pages 99 and 100).

Functions	Display indications	Your unit	Other compatible machine
Transmission passcode check mode	TX PASSCODE CHECK	ON	ON/OFF
Reception passcode check mode	RX PASSCODE CHECK	ON	ON/OFF

Your unit transmits and receives a document only when the correct passcode has been received.

■ **To have facsimile communications within a designated group of people:**

All the people in the group must set both the transmission and reception passcode check modes to on (see pages 99 and 100).

Functions	Display indications	Your unit	Other compatible machine
Transmission passcode check mode	TX PASSCODE CHECK	ON	ON
Reception passcode check mode	RX PASSCODE CHECK	ON	ON

Only units that share identical passcodes can transmit and receive documents each other.

Programming the network passcode

To activate this feature, the identical network passcode must be pre-programmed, both on your unit and on the other compatible machine(s).

The network passcode may be any 4-digit number except "0000".

IMPORTANT:

- The network passcode is pre-programmed to "0000", which will not activate the network communication.

1

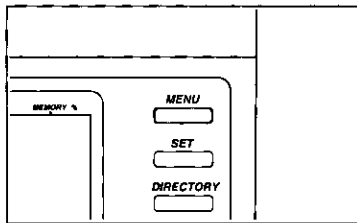

Press **MENU** until the following is shown.

```

PROG. [1.DATE 2.TEL
3.SYSTEM 4.REPORT]
    
```

2

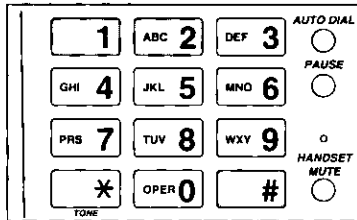

Press #, then press 12 to start programming.

```

NETWORK PASSCODE
=0000
    
```

3

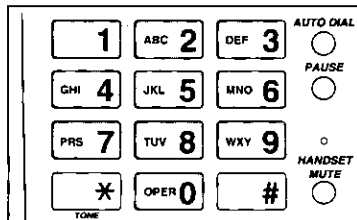

Enter the desired 4-digit passcode (choose 0001 to 9999).

- To correct an error, use the cursor key (◀ or ▶) to move the cursor to the incorrect number, then make the correction.

4

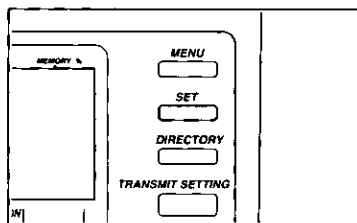

Press **SET** to store the program into memory.

```

PROG. [1.DATE 2.TEL
3.SYSTEM 4.REPORT]
    
```

5

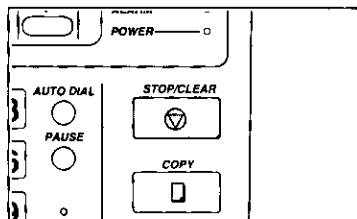

Press **STOP/CLEAR** to end the operation.

Turning on the transmission passcode check mode

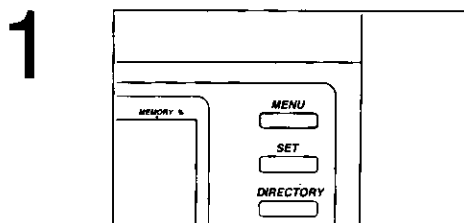

Press **MENU** until the following is shown.

PROG. [1.DATE 2.TEL
3.SYSTEM 4.REPORT]

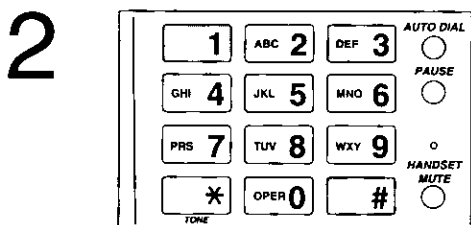

Press #, then press **13** to start programming.

TX PASSCODE CHECK
=OFF [1.ON 2.OFF]

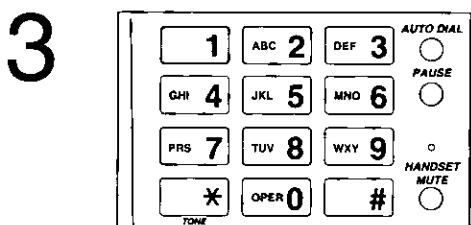

Press **1** to activate this feature.

TX PASSCODE CHECK
=ON [1.ON 2.OFF]

- To turn off the transmission passcode check mode, press **2**.

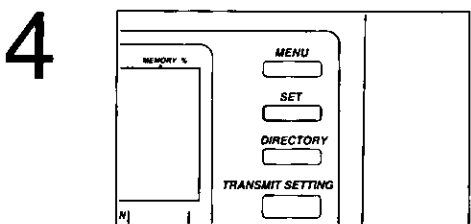

Press **SET** to store your selection into memory.

PROG. [1.DATE 2.TEL
3.SYSTEM 4.REPORT]

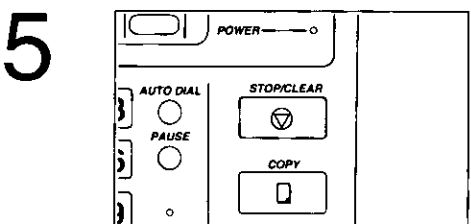

Press **STOP/CLEAR** to end the operation.

3

Turning on the reception passcode check mode

1

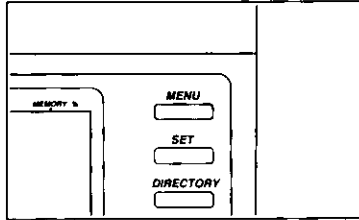

Press **MENU** until the following is shown.

PROG. [1.DATE 2.TEL
3.SYSTEM 4.REPORT]

2

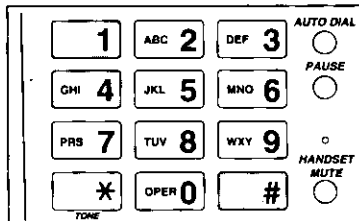

Press **#**, then press **14** to start programming.

RX PASSCODE CHECK
=OFF [1.ON 2.OFF]

3

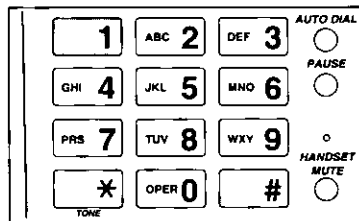

Press **1** to activate this feature.

RX PASSCODE CHECK
=ON [1.ON 2.OFF]

– To turn off the reception passcode check mode, press **2**.

4

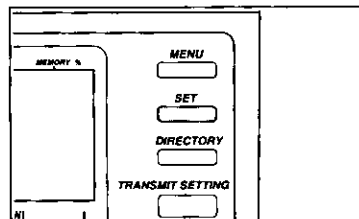

Press **SET** to store your selection into memory.

PROG. [1.DATE 2.TEL
3.SYSTEM 4.REPORT]

5

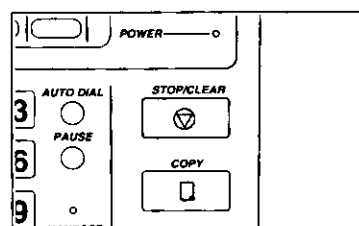

Press **STOP/CLEAR** to end the operation.

Forwarding Received Documents

Once you turn this feature on, your unit will store the received documents into memory, and transmit them automatically to another specified facsimile machine successively. After forwarding, the documents stored into memory will be erased. If the unit is unable to forward the documents, they will remain in memory, and they can be manually retrieved.

– Concerning the memory capacity for storing documents, see page 7.

IMPORTANT:

– The fax forwarding feature can be turned on when the receiving mode is set to the *TEL/FAX* mode.

1

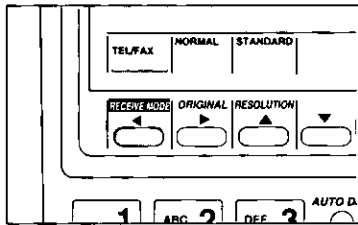

Set the receiving mode to the *TEL/FAX* mode.

2

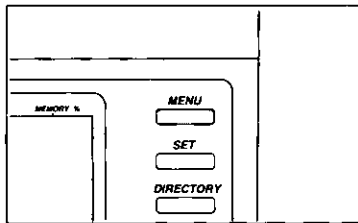

Press **MENU** until the following is shown.

```

PROG. [1.DATE 2.TEL
        3.SYSTEM 4.REPORT]
    
```

3

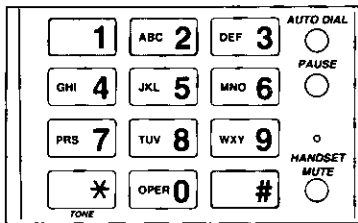

Press #, then press **21** to start programming.

```

FAX FORWARDING
=OFF      [1.ON 2.OFF]
    
```

4

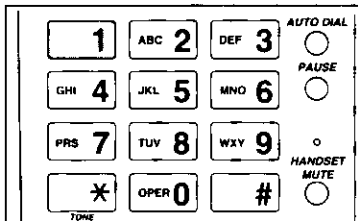

Press **1** to activate this feature.

```

FAX FORWARDING
=ON       [1.ON 2.OFF]
    
```

– To turn off the forwarding feature, press **2**.

(continued)

3

5

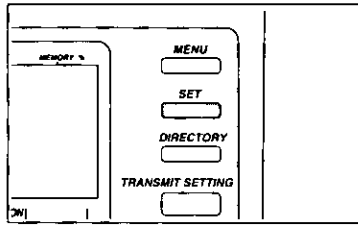

Press **SET** to store your selection into memory.

FORWARDING PHONE #
=

– If the receiving mode is set to the mode except the *TEL/FAX* mode, the following message will be displayed:

CHANGE RECEIVE MODE
TO TEL/FAX

Press **RECEIVE MODE** to set the *TEL/FAX* mode.

6

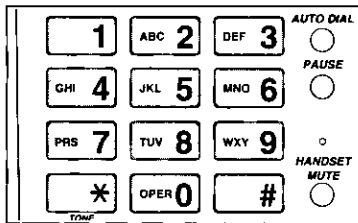

Enter the phone number of the receiving unit.

Example: The forwarding phone number is 9876543.

FORWARDING PHONE #
=9876543

– The phone number can be entered up to 30 digits in length.

– You can use the automatic dialer.

7

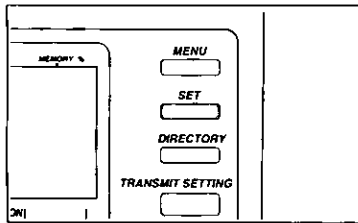

Press **SET** to store the program into memory.

PROG. [1.DATE 2.TEL
3.SYSTEM 4.REPORT]

8

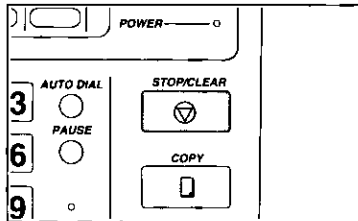

Press **STOP/CLEAR** to end the operation.

When the forwarding feature is set, the display shows:

AUG10 3:00PM 00
FAX FORWARDING ON

NOTES:

- To cancel the programming halfway, press the MENU button.
- This feature can be turned on or off from a remote location. See page 104.
- If there is no answer or the line is busy, the unit will automatically redial the forwarding number. See the item number 7 on page 181.
- If you press the RECEIVE MODE button until the forwarding feature is on, the display will show:

CANCEL FORWARDING ?
[1.YES 2.NO]

Press 1 to cancel the forwarding feature and to change the receiving mode.

Press 2 to continue the forwarding feature.

- If memory becomes full while receiving, the unit will stop receiving documents. And then, the unit will start forwarding the stored documents. If this occurs, the message indicating that all of the pages cannot be forwarded will be printed at the top of the forwarded last page.

Fax forwarding report

After forwarding documents, the unit automatically prints the following report:

Sample of the fax forwarding report:

```
***** FAX FORWARDING REPORT *****
*
*                                     AUG.10.1994  4:03PM
*
*  - RECEIVED BY -      START TIME    RX PAGES    RESULT
*-----
*  0924759269          AUG.10  4:02PM      01          OK
*
*
*  - TRANSFERED TO -    START TIME    TX PAGES    RESULT
*-----
*  092 477 1237        AUG.10  4:03PM      01          OK
*
*
*
*
*
*
*
*
*
*
*****
```

Retrieving mis-forwarded documents

If the documents cannot be forwarded, the display will show the following message (the missed documents will remain in memory):

AUG10 3:42PM 05
CHECK FAX FORWARDING

To retrieve them, proceed as follows:

1

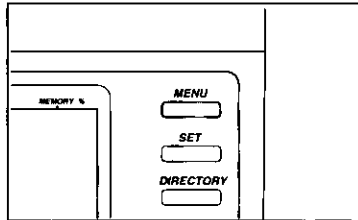

Press **MENU** until the following is shown.

FAX FORWARDING
PRESS SET TO PRINT

2

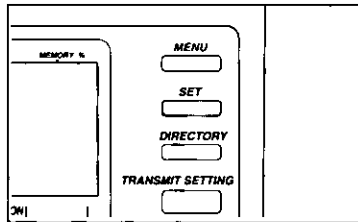

Press **SET** to print the documents.

The unit starts printing.

FAX FORWARDING
PRINTING

Turning on or off the forwarding feature from a remote location

The following operation activates or de-activates the forwarding feature from a remote location.

IMPORTANT:

- Use a touch-tone telephone with tone dialing for this operation.
- This feature is available only in the *TEL/FAX* mode.

1



Call your unit.

2

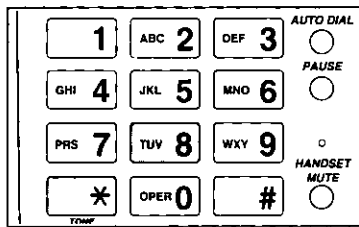

- **When turning on the forwarding feature:**
Press * and 8 using tone dialing while ringing.

After a beep, the forwarding feature is turned on.

or

or

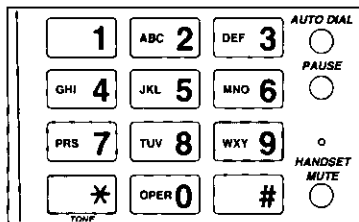

- **When turning off the forwarding feature:**
Press * and 9 using tone dialing while ringing.

After two beeps, the forwarding feature is turned off.

3

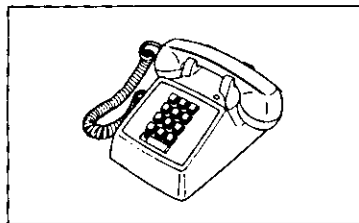

Hang up.

NOTES:

- If a continuation of short beeps sounds, you will fail in the remote operation. Press the button firmly within 30 seconds.
- If a forwarding phone number is not programmed in the unit, this feature cannot be used.

3

Using the TRANSMIT SETTING Button

The TRANSMIT SETTING button allows for the printing of the total page number and the special message at the top of all transmitted pages, and for the setting of the overseas transmission mode.

Total page number and the special message

The total page number and the special message that are pre-programmed in your unit can be printed at the top of all transmitted pages.

You can choose the desired message among the following:

- A: CONFIDENTIAL
- B: URGENT REPLY REQUEST
- C: URGENT PLEASE READ
- D: personal message (see page 109)

Sample page transmitted from your unit:

e.g. The message "CONFIDENTIAL" is selected.

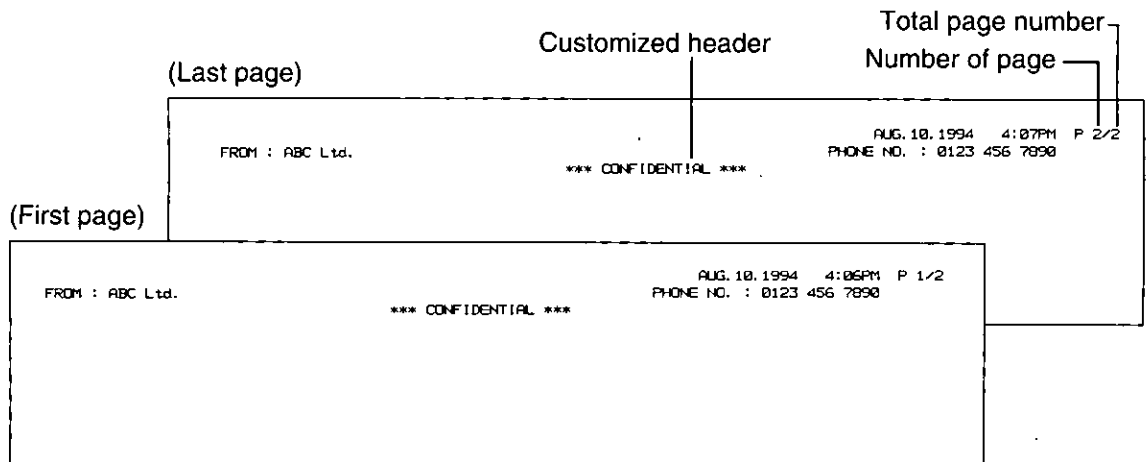

NOTE:

– When transmitting the documents by using the following functions, the unit will automatically print the total page number, regardless of the setting:

- Delayed memory transmission (see page 81)
- Polled mode (see page 86)
- Multistation transmission (see page 90)
- Memory transmission (see page 93)

Overseas transmission mode

If there is difficulty in transmitting documents overseas, use the overseas transmission mode. To set this mode, follow the steps below:

NOTES:

- When the overseas transmission mode is set, the time required to make the transmission will be longer than normal.
- The overseas transmission mode cannot be used in combination with delayed, multi, or memory transmission.
- If a transmission error still occurs in the overseas transmission mode, lower the transmission speed (see page 139), and try again. Or, when dialing the phone number, add two pauses at the end of the number by pressing the PAUSE button (see page 116).

3

Transmitting documents with the TRANSMIT SETTING button

To set the total page number, the customized header, or the overseas transmission mode, follow the steps below:

HELPFUL HINT:

- If you lose your instructions while operating, press the HELP button. The unit will print information on how to operate.

1

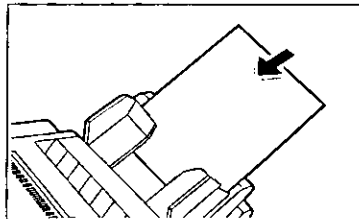

Insert the documents FACE DOWN.

- The unit can accept up to 20 pages at a time.

2

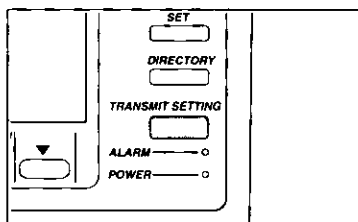

Press **TRANSMIT SETTING** until the following is shown.

SET NUMBER OF PAGES
TOTAL=0

3

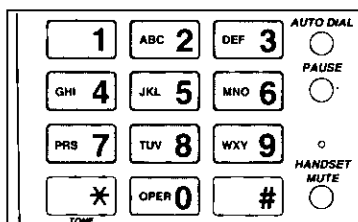

Enter the total number of pages (1 to 99).

- If the total page number is unnecessary, press 0 or skip this step and go to step 4.

(continued)

4

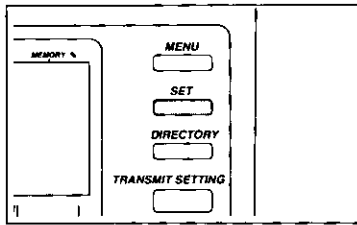

Press **SET** to store the number into memory.

MESSG. OUT =OFF [1.A 2.B 3.C 4.D 5.OFF]
--

5

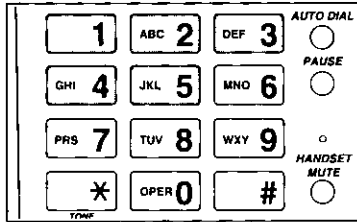

Enter the number of the selection you desire.

Setting selections:

- 1: A (CONFIDENTIAL)
- 2: B (URGENT REPLY REQUEST)
- 3: C (URGENT PLEASE READ)
- 4: D (a personal message) (see page 109)
- 5: OFF (a message will not print.) (pre-selected setting)

- If the special message is unnecessary, skip this step and go to step 6.

6

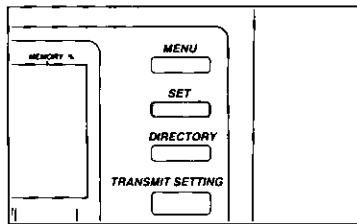

Press **SET** to store your selection into memory.

OVERSEAS MODE =OFF [1.ON 2.OFF]

7

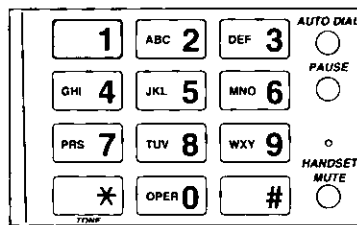

Press **1** to activate the overseas transmission mode.

- To de-activate the overseas transmission mode, press 2.
- If the overseas transmission mode is unnecessary, skip this step and go to step 8.

8

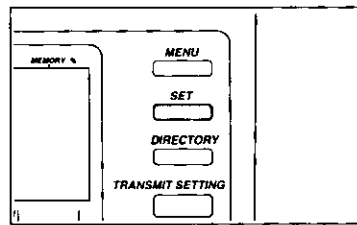

Press **SET** to store your selection into memory.

AUG10 3:00PM 00

9

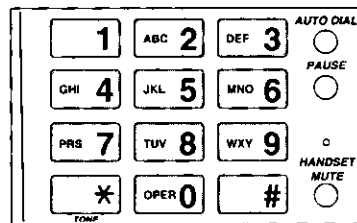

Enter the desired phone number.

- You can use the automatic dialer.

(continued)

10

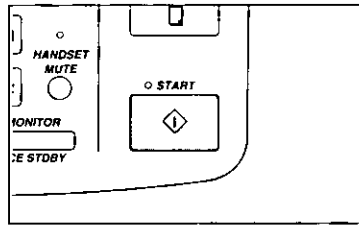

Press **START**.

The unit dials and then transmits documents automatically.

NOTE:

– These features will automatically be turned off after each transmission has been completed.

Programming a personal message

A programmed personal message can be printed at the top of all transmitted pages. This message will be printed only when requested through transmission with the TRANSMIT SETTING button (see page 107).

Example: A personal message is "WELCOME to Quasar".

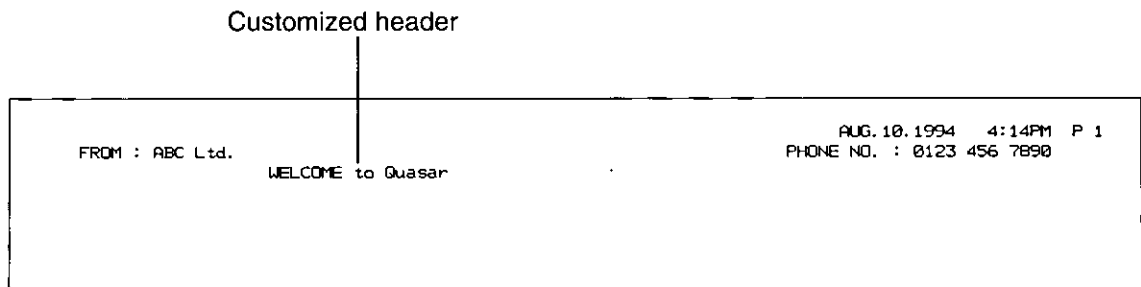

To program a personal message, proceed as follows:

1

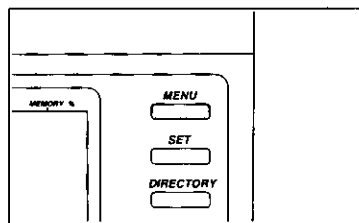

Press **MENU** until the following is shown.

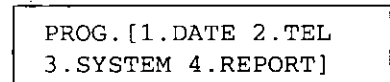

2

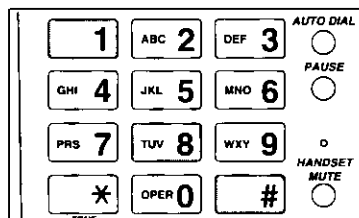

Press **#**, then press **18** to start programming.

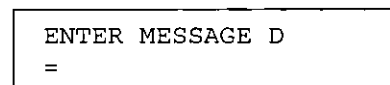

(continued)

3

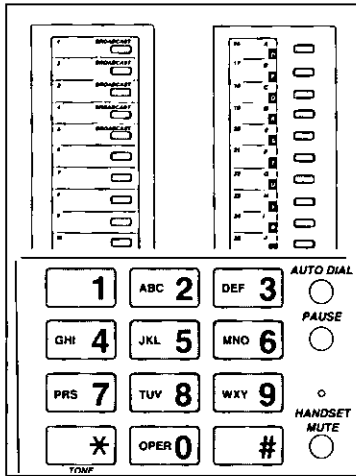

Enter the message up to 64 characters you wish to print by using the character keys.

- To use the character keys, see page 37.

ENTER MESSAGE D
 =WELCOME to Quasa

4

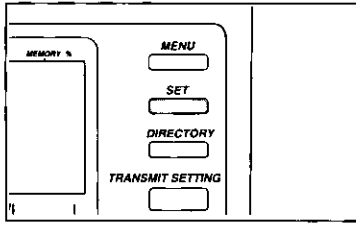

Press **SET** to store the program into memory.

PROG. [1.DATE 2.TEL
 3.SYSTEM 4.REPORT]

5

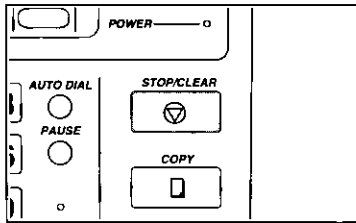

Press **STOP/CLEAR** to end the operation.

- To transmit a document with the personal message that you programmed, use **TRANSMIT SETTING** (see page 107) and select "4" (D: a personal message) in step 5.

Making Voice Calls Using Automatic Dialer

The unit's memory allows both one-touch dialing (up to 30 phone numbers) and speed dialing (up to 100 phone numbers) for rapid access to the most frequently called numbers. Before using these features, make sure that the desired telephone numbers have been stored into memory (see pages 58 to 66).

HELPFUL HINT:

- If you lose your instructions while operating, press the HELP button. The unit will print information on how to operate.

1

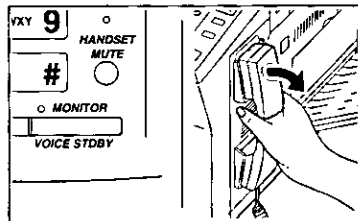

Press **MONITOR** or lift the handset and listen for the dial tone.

2

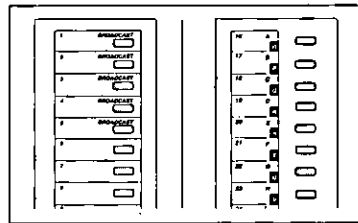

■ Using one-touch dialing:

Press the desired direct call station key.

- To use the station number 16 to 30, open the station key cover and press the direct call station key.

or

or

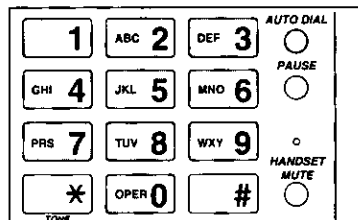

■ Using speed dialing:

Press **AUTO DIAL**.

Then press the desired station number (00 to 99).

3



When the other party answers your call, lift the handset and talk into it.

NOTE:

- If there is no answer or you wish to redial the last dialed number, you can use the REDIAL button. See page 56.

3

Making voice calls using the electronic telephone directory

You can make voice calls using the electronic telephone directory feature by selecting the desired name from the display.

Make sure that the desired telephone numbers and their names have been stored into memory (see pages 58 to 66).

1

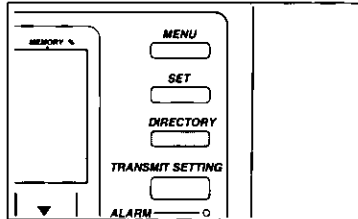

Press **DIRECTORY**.

```
SELECT INDEX
A-Z, 0-9, #
```

2

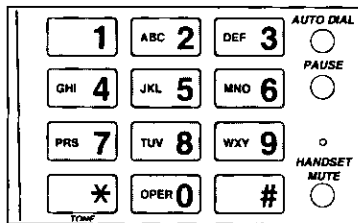

■ To access the desired index directly:
Enter the desired index (see page 74).

The first name in the index is displayed.

```
SELECT NAME <XXX>
=XXXXXXXXXX
```

or

or

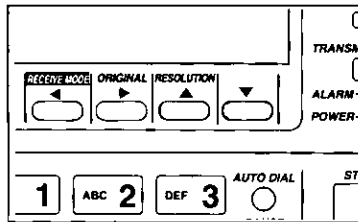

■ To look up the desired name in alphabetical order:

Press ▼ or ▲ until the desired name is shown.
Skip step 3 and go to step 4.

3

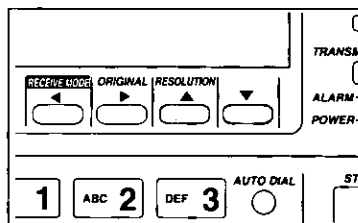

Press ▼ or ▲ until the desired name is shown.
Use ▼ to advance the stored names, or ▲ to go back.

```
SELECT NAME <XXX>
=XXXXXXXXXX
```

4

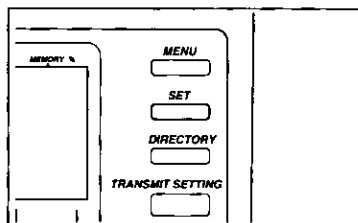

Press **SET**.

```
AUG10 3:00PM 00
<XXXXXXXXXX>
```

The unit starts dialing.

Initiating voice contact

While transmitting or receiving a document, you may wish to speak to the other party. If the other party's unit is equipped with a voice contact feature, you can initiate voice contact and notify the other party after the transmission/reception has been completed. The other party's unit will emit a distinctive ring indicating that a voice conversation is required.

This saves the extra expense and time of making a subsequent telephone call to discuss information sent over the fax.

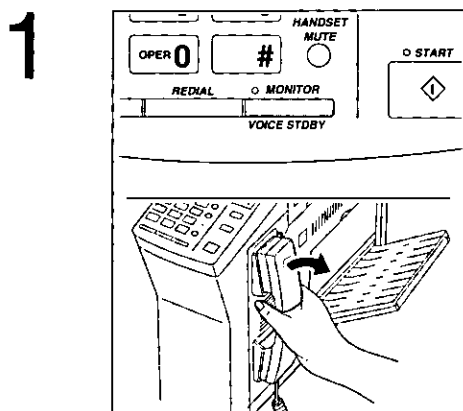

Press **MONITOR/VOICE STDBY** or lift the handset while transmitting or receiving the documents.

SENDING PXX
VOICE STANDBY

or

RECEIVING PXX
VOICE STANDBY

– If you press **MONITOR/VOICE STDBY**, the **MONITOR/VOICE STDBY** indicator light is on.

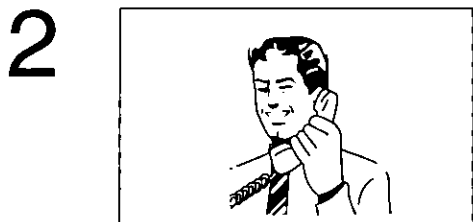

When the other party answers, speak using the handset.

- If you initiate voice contact while transmitting documents, you can speak after all the documents have been transmitted.
- If you initiate voice contact while receiving documents, you can speak after receiving the current page of the documents.

Continuing the transmission or reception after voice contact:

■ To continue the transmission:

1. Ask the other party to press their start or transmit button.
2. Listen for the fax tone, and confirm that the documents are loaded in your unit.
3. Press the **START** button.
4. Replace the handset.

■ To continue the reception:

1. Ask the other party to continue the transmission.
2. Press the **START** button.
 - When the other party begins the transmission, the unit will start receiving documents.

Receiving a request for voice contact

If the other party initiates voice contact during transmission or reception, your unit will emit a distinctive ring after the transmission/reception is completed.



When a distinctive ring is heard, lift the handset, then start speaking.

SENDING	PXX
PICK UP THE HANDSET	

or

RECEIVING	PXX
PICK UP THE HANDSET	

NOTE:

- If you do not answer within 10 seconds of hearing the distinctive ring, the line will be disconnected.

TONE, FLASH, PAUSE, and MUTE Buttons

Changing from pulse to tone mode (TONE button)

This function is only effective when your line has a rotary pulse dial service. Pressing the TONE (*) button will allow the change of the dialing mode to tone mode during a dialing operation. Whichever dial service your line has, you can enter special tones and codes to operate the answering device, electronic banking services, call processing services, and other special services.

Using the TONE button:

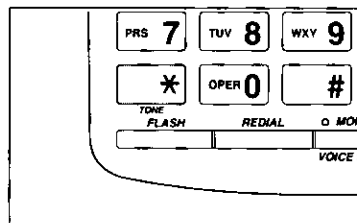

Press **TONE (*)**.

– When you hang up, the unit will automatically return to pulse mode.

NOTES:

- TONE can be stored into memory (see pages 59 to 66).
- Pressing the TONE button counts as 1 digit while programming.

Accessing features of your host exchange (FLASH button)

Pressing the FLASH button will allow you to access the special features of your host exchange or local telephone company services.

For further details, contact your telephone company for information about the availability of services.

Using the FLASH button:

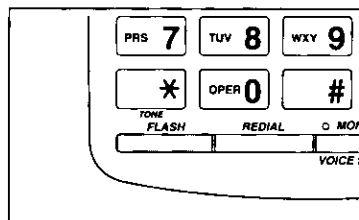

Press **FLASH** lightly when required.

NOTES:

- FLASH can be stored into memory (see pages 59 to 66).
- Pressing the FLASH button counts as 1 digit while programming.

Inserting a pause into a phone number (PAUSE button)

If your unit is connected to a private branch exchange (PBX), you need to dial an access number to get an outside line. A pause must be inserted between the access number and the phone number, especially when storing the number into memory or redialing. Pressing the PAUSE button causes a dialing delay in the dialing sequence. If a transmission error occurs frequently when making an overseas transmission, add two pauses at the end of the phone number.

Using the PAUSE button:

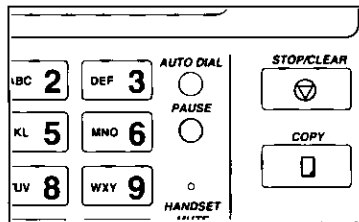

Press **PAUSE** when required.

Example-1: Dial or store the phone numbers as follows when the line access number of your exchange is 9.

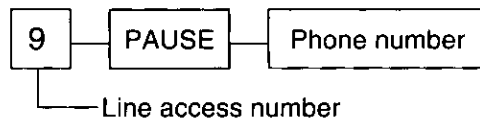

Example-2: Dial or store the phone numbers as follows to make an overseas transmission.

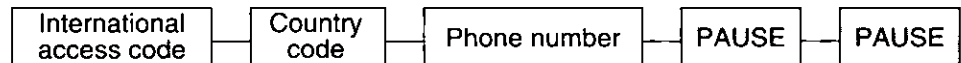

NOTES:

- PAUSE can be stored into memory (see pages 59 to 66).
- Pressing the PAUSE button counts as 1 digit while programming.

Voice muting (HANDSET MUTE button)

The HANDSET MUTE button will mute your voice during a telephone conversation. You can hear the voice of the other party, but the other party cannot hear your voice.

Using the HANDSET MUTE button:

■ To mute your voice:

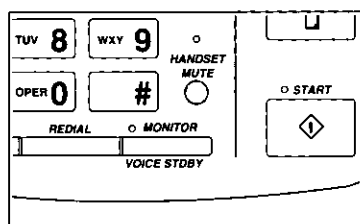

Press **HANDSET MUTE** during a conversation.

The HANDSET MUTE indicator light is on.

– Your voice is not heard by the other party.

■ To resume the conversation:

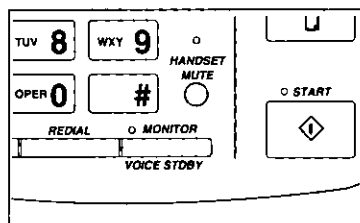

Press **HANDSET MUTE** again.

The HANDSET MUTE indicator light goes out.

Reserve Phone

If you connect a reserve telephone on the same line to which your facsimile unit is connected, you can make and answer voice calls by using the reserve telephone. Remember the following notice when using the reserve telephone.

When a call comes in, the reserve telephone will ring according to the setting of the receiving mode of your facsimile unit as follows:

■ **When receiving a call in the *TEL/FAX* mode:**

The reserve telephone rings depending on the setting of the number of rings of the reserve telephone before your facsimile unit rings.

- You can change the ring count of the reserve telephone. See page 137.
- If someone does not answer the call with the reserve telephone, your facsimile unit will ring depending on the setting of the silent fax recognition ring (see page 127). In this case, your facsimile unit will emit the distinctive tone to the caller.

■ **When receiving a call in the *FAX* mode:**

Both the reserve telephone and your facsimile unit ring depending on the setting of the number of rings in the *FAX* mode before your facsimile unit automatically switches to fax.

- You can change the ring count. See page 122.

■ **When receiving a call in the *TEL* mode:**

Both the reserve telephone and your facsimile unit continue ringing until someone answers the call. If someone does not answer the call before the unit rings 15 times, your facsimile unit will automatically switch to the *TEL/FAX* mode.

If a power failure occurs, your facsimile unit will not function. We recommend using the reserve telephone as a standard telephone.

NOTE:

- If the reserve telephones are connected to the same line, do not use the reserve telephones during fax transmission and reception. Otherwise image quality will be affected.

Chapter 4

Registration

Contents

	Page
Setting the Individual Transmission Report Printing	120
Selecting the Number of Rings in the FAX Mode	122
Setting the Logo Print Position	123
Setting the Journal Report Printing	124
Setting the automatic journal report printing	125
Printing the journal report manually	126
Selecting the Number of Fax Recognition Rings	127
Setting the Copy Mode	128
Setting the reduction or inhibition mode	128
Making extension copies	130
Setting the Receiving Reduction Mode	132
Additional Feature for Distinctive Ring Service	134
Programming your unit with distinctive ringing pattern	134
Adjusting the Display Contrast	136
Selecting the Number of Rings of Reserve Phone	137
Setting the Transmission Speed	139
Setting the Message Alert	140
Resetting the System Programming Features	141
Printing the System Programming List	143

Setting the Individual Transmission Report Printing

Once fax transmission has terminated, the unit will print a record of the transmission.

The following selections are available:

ERROR: The report will print only when the transmission fails (pre-selected setting).

ON: The report will print, indicating whether the transmission is successful or not.

OFF: The report will not print.

Sample of the transmission report:

***** XMT REPORT *****							
* No.	OTHER FACSIMILE	START TIME	USAGE TIME	MODE	PAGES	RESULT	
* 01	092 477 1237	AUG. 10 4:20PM	00'56	TX	02	OK	
* * * * *							

- ① Print date and time
- ② Communication number
- ③ Dialed number or other party's name (Maximum 20 characters)
- ④ Communication start time
- ⑤ Length of communication (Maximum 59' 59")
- ⑥ Transaction mode:
TX...Transmission
- ⑦ Number of pages transmitted successfully (Maximum 99 pages)
- ⑧ Communication result

NOTE:
 – For the explanation of communication results, see page 149.

To change the individual transmission report setting, proceed as follows:

HELPFUL HINT:

- If you lose your instructions while programming, press the HELP button. The unit will print information on how to program.

1

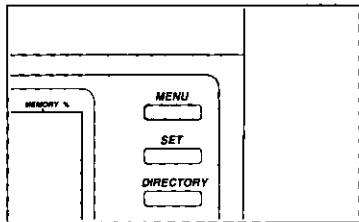

Press **MENU** until the following is shown.

PROG. [1 .DATE 2 .TEL
3 .SYSTEM 4 .REPORT]

2

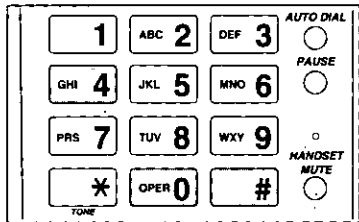

Press **#**, then press **04** to start programming.

XMT REPORT =ERROR
[1 .ERROR 2 .ON 3 .OFF]

3

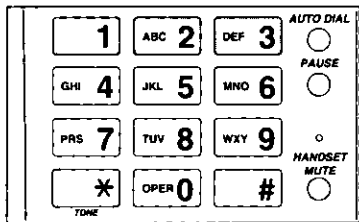

Enter the number of the mode you desire.

Setting selections:

- 1: ERROR (only when any trouble occurred)
- 2: ON (everytime after transmission)
- 3: OFF (de-activation of this feature)

4

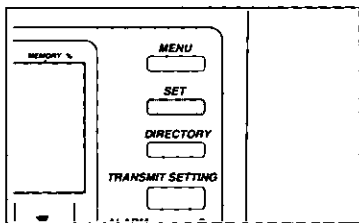

Press **SET** to store your selection into memory.

PROG. [1 .DATE 2 .TEL
3 .SYSTEM 4 .REPORT]

5

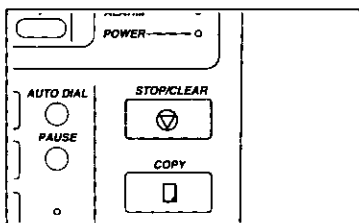

Press **STOP/CLEAR** to end the operation.

4

Selecting the Number of Rings in the FAX Mode

When in the *FAX* mode, the unit will automatically answer on the first ring as a pre-selected setting when receiving a call. You can change the number of rings to answer a call from 1 to 4.

HELPFUL HINTS:

- If you wish to have the opportunity to pick up the handset before the call is answered by the unit, increase the number of rings.
- If there is difficulty in receiving faxes from machines that have an automatic transmission feature, decrease the number of rings.
- If you lose your instructions while programming, press the HELP button. The unit will print information on how to program.

To change the number of rings in the *FAX* mode, proceed as follows:

1

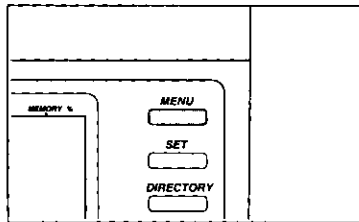

Press **MENU** until the following is shown.

```

PROG. [1.DATE 2.TEL
3.SYSTEM 4.REPORT]
    
```

2

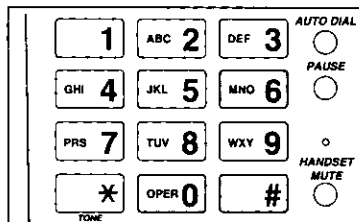

Press #, then press **06** to start programming.

The display shows the current setting.

```

FAX RING
COUNT=1      [1-4]
    
```

3

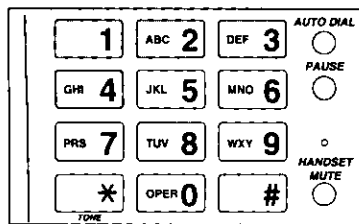

Enter the desired number of rings from 1 to 4.

4

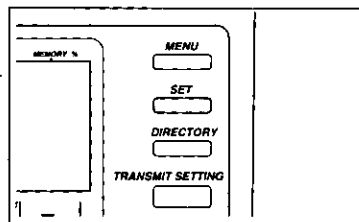

Press **SET** to store your selection into memory.

```

PROG. [1.DATE 2.TEL
3.SYSTEM 4.REPORT]
    
```

5

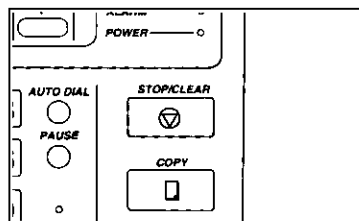

Press **STOP/CLEAR** to end the operation.

Setting the Logo Print Position

Your logo, your telephone number, date, time, and page number will be printed on the transmitted document from your unit in the following manner:

OUT: Outside of the transmitted document's paper size (pre-selected setting).

IN: Inside of the transmitted document's paper size.

To change the setting, proceed as follows:

1

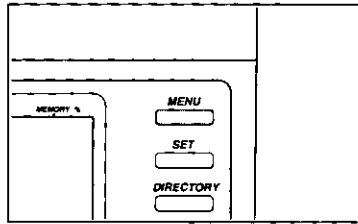

Press **MENU** until the following is shown.

PROG. [1.DATE 2.TEL
3.SYSTEM 4.REPORT]

2

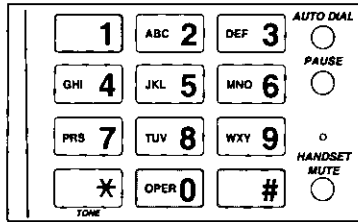

Press #, then press **10** to start programming.

LOGO POSITION=OUT
[1.OUT 2.IN]

3

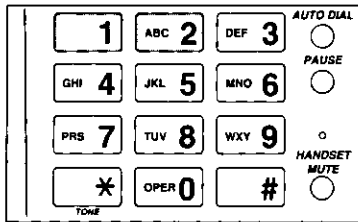

Press the number of the selection you desire.

Setting selections:
1: OUT (Outside)
2: IN (Inside)

4

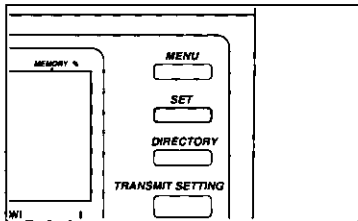

Press **SET** to store your selection into memory.

PROG. [1.DATE 2.TEL
3.SYSTEM 4.REPORT]

5

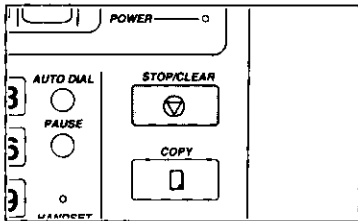

Press **STOP/CLEAR** to end the operation.

4

Setting the Journal Report Printing

You can obtain a record of the last 30 transactions (transmissions and receptions) automatically or manually. This report is useful for keeping telephone records or for verifying long distance telephone charges.

AUTO: The journal report will automatically print after 30 transactions. After that, the journal report data will clear and the unit will begin to store data of the journal report into memory (pre-selected setting).

MANUAL: The journal report will not print automatically. But the journal report data will be stored in memory. When memory is full and a new transaction takes place, the earliest data will be erased and the newest data will be stored.

Regardless of above setting, the journal report is available whenever you request. See page 126.

Sample of the journal report:

***** JOURNAL *****								
AUG. 11. 1994 11:38AM								
* No.	OTHER FACSIMILE	START TIME	USAGE TIME	MODE	PAGES	RESULT	*CODE	
* 01	0924759269	AUG. 10 5:55PM	00'22	TX	00	PRESSED THE STOP KEY		
* 02	092 987 6543	AUG. 10 5:57PM	00'59	TX	00	PRESSED THE STOP KEY		
* 03	092 987 6543	AUG. 10 5:58PM	00'07	TX	00	NO DOCUMENT		
* 04	092 987 6543	AUG. 10 5:59PM	00'44	TX	01	OK		
* 05	092 987 6543	AUG. 10 6:01PM	00'25	RX	00	COMMUNICATION ERROR	(71)	
* 06	INCOMING	AUG. 10 6:02PM	00'08	RX	00	COMMUNICATION ERROR	(54)	
* 07	092 987 6543	AUG. 10 6:03PM	01'01	TX	00	COMMUNICATION ERROR	(42)	
* 08	0987654321	AUG. 10 6:06PM	00'43	TX	01	OK		
* 09	0929876543	AUG. 10 6:07PM	00'08	TX	00	NO DOCUMENT		
* 10	0929876543	AUG. 10 6:07PM	00'08	TX	00	NO DOCUMENT		
* 11	<A00>	AUG. 10 6:08PM	00'41	TX	00	NO RESPONSE		
* 12	0929876543	AUG. 10 6:09PM	00'44	TX	01	OK		
* 13	0922582580	AUG. 11 11:36AM	00'08	TX	00	PRESSED THE STOP KEY		
* 14	0922582580	AUG. 11 11:36AM	00'46	TX	01	OK		

- ① Print date and time
- ② Communication number (up to 30)
- ③ Dialed number or other party's name (Maximum 20 characters)
- ④ Communication start time
- ⑤ Length of communication (Maximum 59'59")
- ⑥ Transaction mode:
 - TX Transmission
 - RX Reception
 - POL.TX Transmission by polled
 - POL.RX Reception by polling
 - FORW.TX Transmission by forwarding
 - FORW.RX ... Reception for forwarding
- ⑦ Number of pages received or transmitted successfully (Maximum 99 pages)
- ⑧ Communication result
- ⑨ Error code (For the service center use only.)

NOTE:

- For the explanation of communication results, see page 149.

Setting the automatic journal report printing

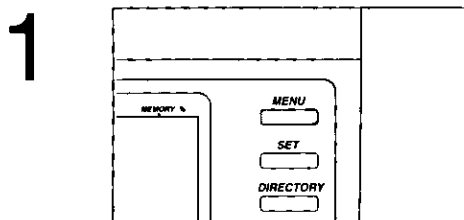

Press **MENU** until the following is shown.

```

PROG. [1.DATE 2.TEL
3.SYSTEM 4.REPORT]
    
```

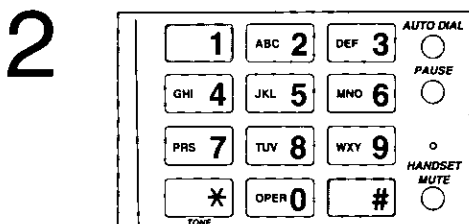

Press #, then press **11** to start programming.

```

JOURNAL=AUTO
[1.AUTO 2.MANUAL]
    
```

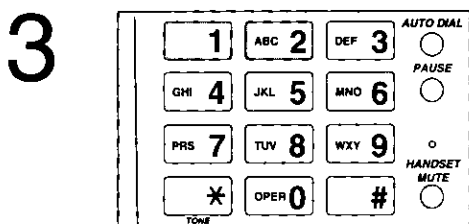

Press the number of the selection you desire.

Setting selections:

- 1: AUTO (automatic journal report printing)
- 2: MANUAL (not automatic printing)

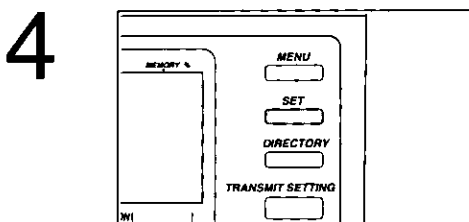

Press **SET** to store your selection into memory.

```

PROG. [1.DATE 2.TEL
3.SYSTEM 4.REPORT]
    
```

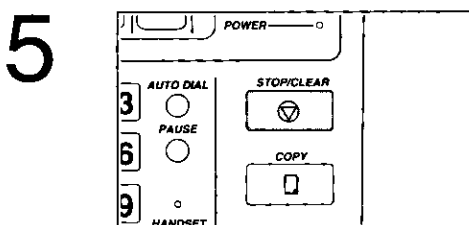

Press **STOP/CLEAR** to end the operation.

Printing the journal report manually

Upon request, a report of the current journal can be printed. The journal report data will not clear even after printing.

1

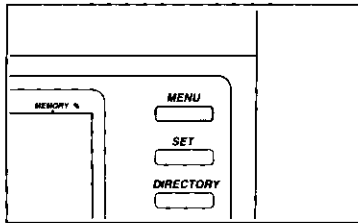

Press **MENU** until the following is shown.

PROG. [1.DATE 2.TEL
3.SYSTEM 4.REPORT]

2

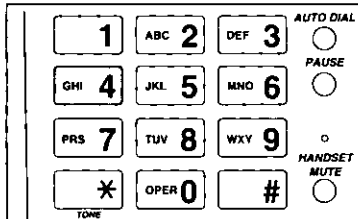

Press 4 to start programming.

SELECT NO. [1.SYSTEM
2.TEL NO. 3.JOURNAL]

3

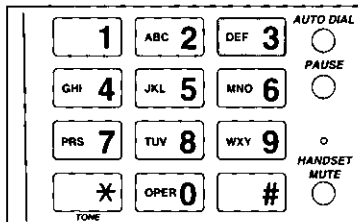

Press 3 to print the journal report.

The unit starts printing.

PRINTING JOURNAL

– If there have been no transactions, a journal report will not print.

4

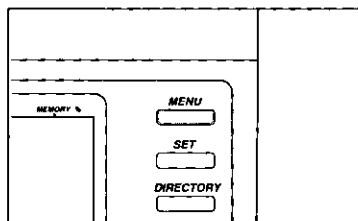

After printing, press **MENU** to end the operation.

Selecting the Number of Fax Recognition Rings _____

When a manual fax transmission or a voice call is received in the *TEL/FAX* mode, the unit will emit the distinctive ring three times as a pre-selected setting until it will automatically switch to fax. (We call this ring "silent fax recognition ring".)

When an automatic fax transmission is received in the *TEL/FAX* mode, the unit will receive the fax without ringing.

You can change the number of the fax recognition rings from 3 to 8.

IMPORTANT:

- This feature is effective only in the *TEL/FAX* mode.
- Telephone fees will be charged to the calling party from the first ring because the unit emits the rings after answering a call.

To change the number of rings, proceed as follows:

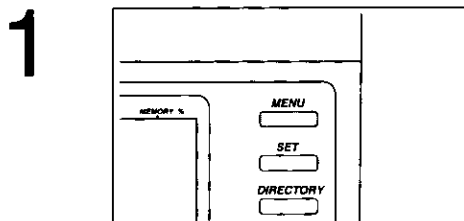

Press **MENU** until the following is shown.

PROG. [1.DATE 2.TEL
3.SYSTEM 4.REPORT]

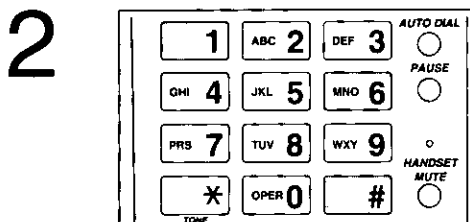

Press #, then press **16** to start programming.

SILENT FAX RECO.
RING COUNT=3 [3-8]

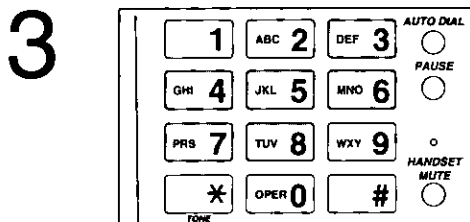

Enter the desired number of rings from 3 to 8.

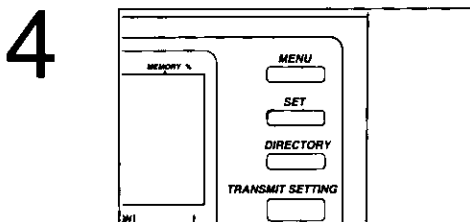

Press **SET** to store your selection into memory.

PROG. [1.DATE 2.TEL
3.SYSTEM 4.REPORT]

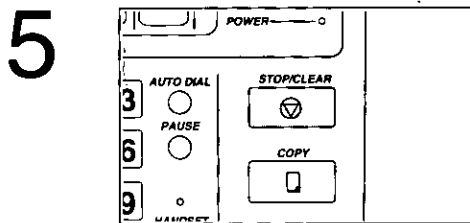

Press **STOP/CLEAR** to end the operation.

Setting the Copy Mode

This mode determines how a copy will be reproduced. One of the following three settings can be selected.

REDUCT: Copies will be reduced to either 86% or 72% of their original length so that they will fit on one page. If an original is large and can not be reduced to fit on one page, the unit will print the copy on two pages without reduction (pre-selected setting).

INHIBIT: Copies will not be reduced. The unit will print the copies on two pages without reduction.

EXTEND: Copies will be extended to 108%, 116%, or 138% of their original length. If a legal-size original is copied, the copy will be printed on two pages. This mode is useful to enlarge received documents that have been reduced by the receiving reduction feature (see page 132).

To make extension copies, see page 130.

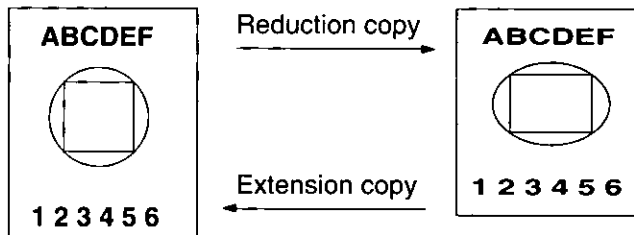

Setting the reduction or inhibition mode

1

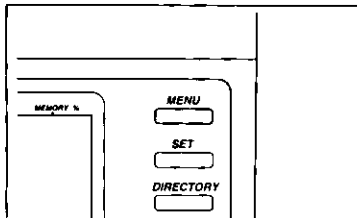

Press **MENU** until the following is shown.

PROG. [1.DATE 2.TEL
3.SYSTEM 4.REPORT]

2

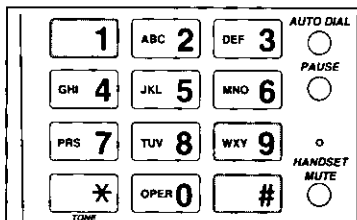

Press #, then press **19** to start programming.

COPY MODE=REDUCT
1.REDT 2.INH 3.EXTND

3



Enter the number of the selection you desire.

Setting selections:

1: REDT (Reduction)

2: INH (Inhibition)

NOTE:

– To make extension copies by selecting EXTND, see page 130.

(continued)

4

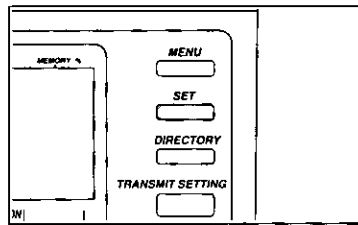

Press **SET** to store your selection into memory.

PROG. [1.DATE 2.TEL
3.SYSTEM 4.REPORT]

5

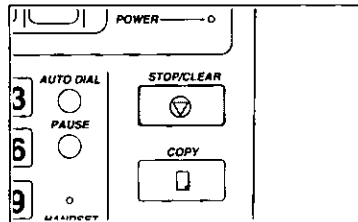

Press **STOP/CLEAR** to end the operation.

– To make copies in the selected copy mode, perform the same procedure for making copies (see page 53).

■ Reduction rate in length:

Size of recording paper	Selections	Size of original document		
		Letter	A4	Legal
Letter 216 × 279 mm (8½" × 11")	REDUCT	100%	86%	72%
	INHIBIT	Divided	Divided	Divided
Legal 216 × 356 mm (8½" × 14")	REDUCT	100%	100%	100%
	INHIBIT	100%	100%	Divided

NOTE:

– A4 size paper may not be available in the United States and Canada.

4

Making extension copies

1

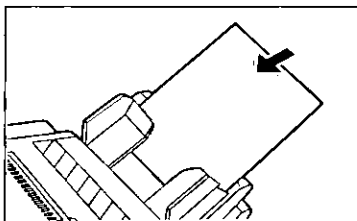

Insert documents FACE DOWN.

– The unit can accept up to 20 pages at a time.

2

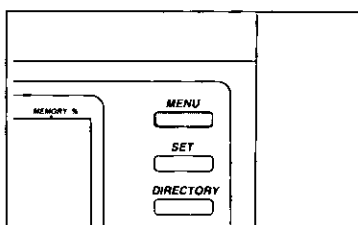

Press **MENU** until the following is shown.

PROG. [1.DATE 2.TEL
3.SYSTEM 4.REPORT]

3

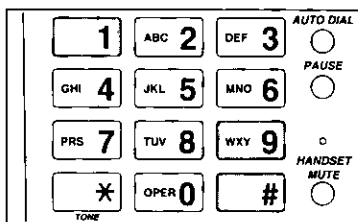

Press #, then press **19** to start programming.

COPY MODE=REDUCT
1.REDT 2.INH 3.EXTND

4



Press **3** to select the extension copy mode.

COPY MODE=EXTND
1.REDT 2.INH 3.EXTND

5

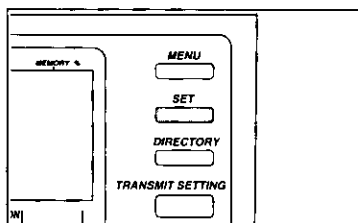

Press **SET** to store your selection into memory.

EXTEND COPY=108%{A}
[1.A 2.B 3.C]

6

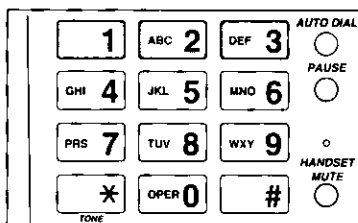

Enter the number of the selection you desire.

Setting selections:

- 1: A (extension rate in length 108%)
- 2: B (extension rate in length 116%)
- 3: C (extension rate in length 138%)

(continued)

7

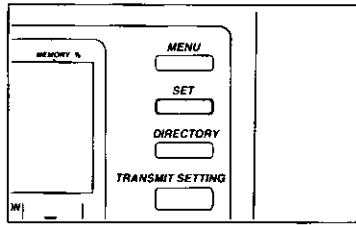

Press **SET** to store your selection into memory.

```
AUG10 3:00PM 00
NUMBER OF COPIES=1
```

– If you need two or more copies, enter the number of copies (up to 70).

8

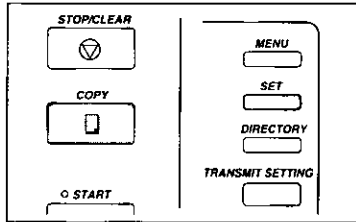

Press **COPY** or **SET** to start making extension copies.

Setting the Receiving Reduction Mode

When receiving a document that is as long or longer than the recording paper installed in your unit, the unit will automatically reduce the data of the document when printing it out. The unit can receive documents in actual size by changing the following copy mode.

REDUCT1: The unit reduces the size of the incoming document to 92% in length to fit on one page. If, after reduction, the unit cannot fit the document on one page, the document will be printed on two pages without reduction .

REDUCT2: The unit reduces the size of the incoming document to 92%, 86%, or 72% in length to fit on one page. If, after reduction, the unit cannot fit the document on one page, the document will be printed on two pages without reduction (pre-selected setting).

INHIBIT: Documents are not reduced. Incoming documents are printed on two pages.

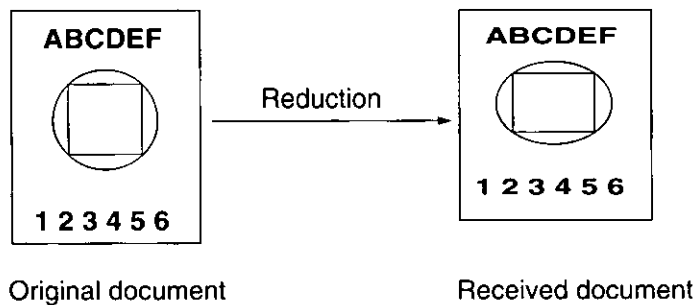

To change the reduction mode, proceed as follows:

1

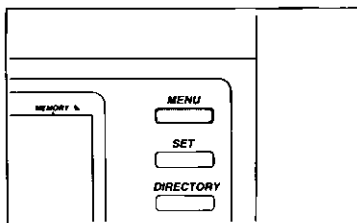

Press **MENU** until the following is shown.

```
PROG. [1.DATE 2.TEL
3.SYSTEM 4.REPORT]
```

2

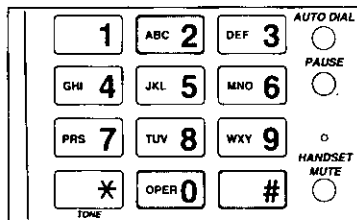

Press #, then press **20** to start programming.

```
RX REDUC.=REDUCT2
1.RED1 2.RED2 3.INH
```

3



Enter the number of the selection you desire.

Setting selections:

- 1: RED1 (Reduction1)
- 2: RED2 (Reduction2)
- 3: INH (Inhibition)

(continued)

4

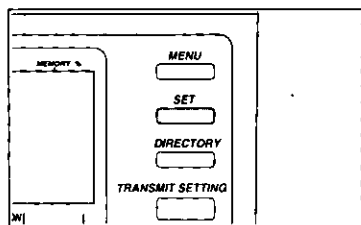

Press **SET** to store your selection into memory.

PROG. [1 . DATE 2 . TEL
3 . SYSTEM 4 . REPORT]

5

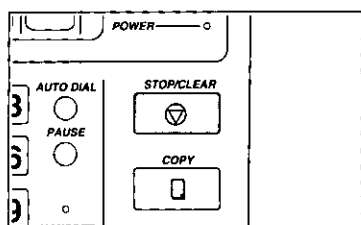

Press **STOP/CLEAR** to end the operation.

■ Reduction rate in length:

Size of recording paper	Selections	Size of document sent by the other party		
		Letter	A4	Legal
Letter 216 × 279 mm (8½" × 11")	REDUCT1	92%	Divided	Divided
	REDUCT2	92%	86%	72%
	INHIBIT	Divided	Divided	Divided
Legal 216 × 356 mm (8½" × 14")	REDUCT1	100%	100%	92%
	REDUCT2	100%	100%	92%
	INHIBIT	100%	100%	Divided

NOTE:

– A4 size paper may not be available in the United States and Canada.

4

Additional Feature for Distinctive Ring Service ---

This unit has been equipped with the ring pattern detection feature, which allows more effective use of the distinctive ring service provided by telephone company.

The distinctive ring service provides up to 3 phone numbers on your regular single telephone line, each with a different ringing pattern. You may use one of the phone numbers as a facsimile number. With the ring pattern detection feature, your unit will detect its own distinctive ringing pattern and automatically activate the fax function to receive documents. If other calls come in, the unit will answer in the receiving mode selected by the RECEIVE MODE button.

■ The table below shows how the unit answers when receiving calls.

Receiving call	Receiving mode of your unit		
	TEL/FAX	FAX	TEL
A call with distinctive ringing pattern	The unit activates the fax function.*	The unit activates the fax function after ringing. The ring count can be changed (see page 122).	The unit rings until you pick up. If you do not answer the call within 15 rings, the unit will automatically switch to the TEL/FAX mode.
Other call	The unit will ring until you pick up.		

* When the unit receives a call with its own distinctive ringing pattern in the TEL/FAX mode, other reserve phones, if connected on the same line, will ring depending on the setting of the number of rings in the FAX mode before the unit answers the call. To change the number of rings, see page 122.

Programming your unit with distinctive ringing pattern

To activate this feature, program the ringing pattern of the phone number to be used as a facsimile number.

Ringing patterns that can be programmed:

- A: Standard ring
- B: Double ring
- C: Triple ring (Short-long-short)
- D: Other triple ring
- OFF: Turning off the ring pattern detection feature (pre-selected setting)

1

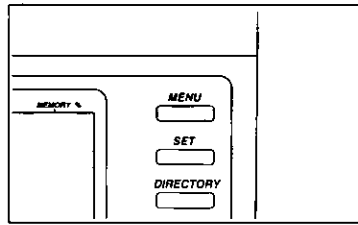

Press **MENU** until the following is shown.

PROG. [1.DATE 2.TEL
3.SYSTEM 4.REPORT]

2

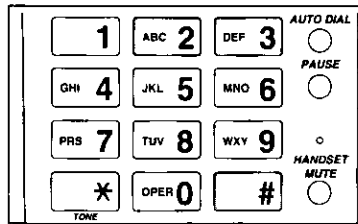

Press #, then press **23** to start programming.

The display shows the current setting.

RING DETECT=OFF [1.A
2.B 3.C 4.D 5.OFF]

3

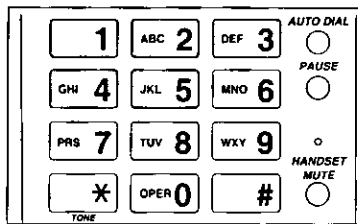

Enter the number of the selection you desire.

Setting selections:

- 1: A (Standard ring)
- 2: B (Double ring)
- 3: C (Triple ring:Short-long-short)
- 4: D (Other triple ring)
- 5: OFF (de-activation of this feature)

4

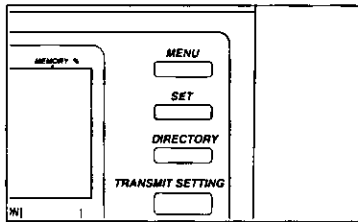

Press **SET** to store your selection into memory.

PROG. [1.DATE 2.TEL
3.SYSTEM 4.REPORT]

5

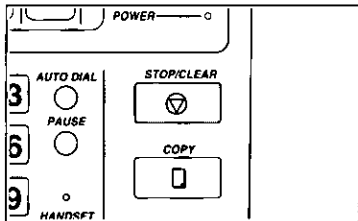

Press **STOP/CLEAR** to end the operation.

4

Adjusting the Display Contrast

You can choose the brightness of the display among three levels (light, normal, or dark). "Normal contrast" is pre-selected.

1

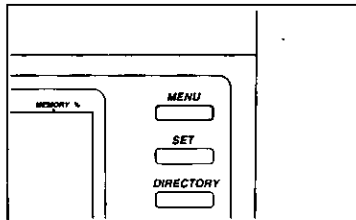

Press **MENU** until the following is shown.

PROG. [1.DATE 2.TEL
3.SYSTEM 4.REPORT]

2

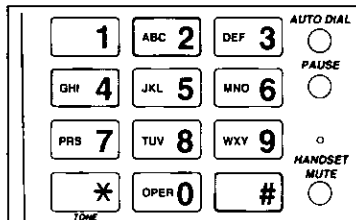

Press #, then press **24** to start programming.

The display shows the current setting.

LCD CONTRAST=NORM
1.LIGH 2.NORM 3.DARK

3

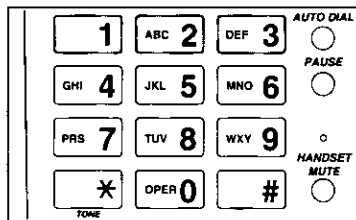

Enter the number of the selection you desire.

Setting selections:

- 1: LIGH (Light)
- 2: NORM (Normal)
- 3: DARK (Dark)

The brightness of the display becomes darker or lighter according to your selection.

4

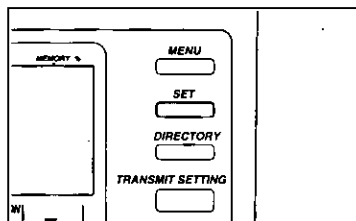

Press **SET** to store your selection into memory.

PROG. [1.DATE 2.TEL
3.SYSTEM 4.REPORT]

5

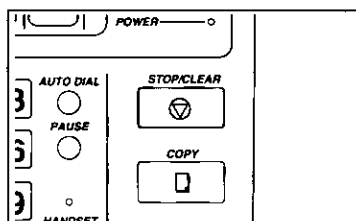

Press **STOP/CLEAR** to end the operation.

Selecting the Number of Rings of Reserve Phone _____

If your unit is set in the *TEL/FAX* mode, the reserve telephone, connected to the same line as your facsimile unit, will ring once (pre-selected setting) when receiving a call. After that, your facsimile unit will ring with the distinctive tone depending on the setting of the silent fax recognition ring (see page 127). You can change the number of rings of the reserve telephone from 1 to 4 by programming your unit. While your facsimile unit is ringing, the reserve telephone does not ring any more.

HELPFUL HINTS:

- If you wish to have the opportunity to answer a call by using the reserve telephone before the call is answered by your facsimile unit, increase the number of rings.
- If there is difficulty in receiving faxes from machines that have an automatic transmission feature, decrease the number of rings .

To change the number of rings of the reserve telephone in the *TEL/FAX* mode, proceed as follows:

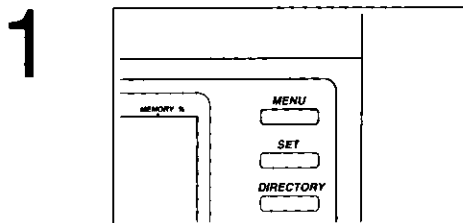

Press **MENU** until the following is shown.

PROG. [1.DATE 2.TEL
3.SYSTEM 4.REPORT]

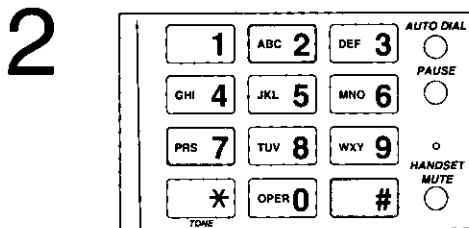

Press #, then press **27** to start programming.

The display shows the current setting.

TEL/FAX DELAYED
RING=1 [1-4]

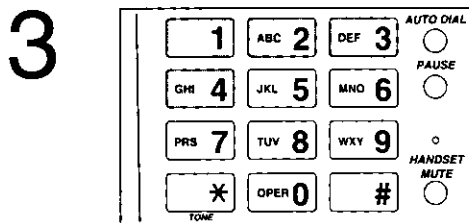

Enter the desired number of rings from 1 up to 4.

(continued)

4

4

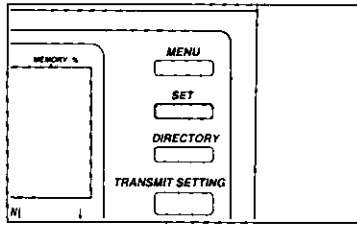

Press **SET** to store your selection into memory.

PROG. [1.DATE 2.TEL
3.SYSTEM 4.REPORT]

5

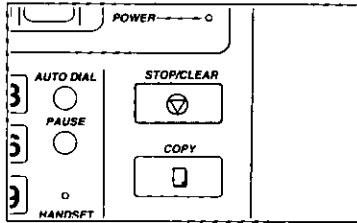

Press **STOP/CLEAR** to end the operation.

Setting the Transmission Speed

The unit automatically selects the optimum transmitting speed, depending on the line condition and the type of the other facsimile unit. But, if problems such as transmission errors caused by poor line condition frequently occur, lower the speed manually by one rank.

The following transmission speeds are available:

- High:** 9600 bits per second (pre-selected setting).
- Middle high:** 7200 bits per second.
- Middle low:** 4800 bits per second.
- Low:** 2400 bits per second.

1

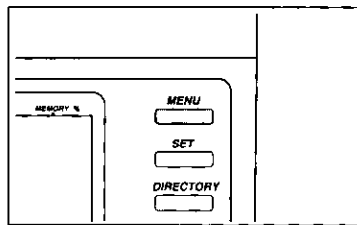

Press **MENU** until the following is shown.

```

PROG. [1.DATE 2.TEL
3.SYSTEM 4.REPORT]
    
```

2

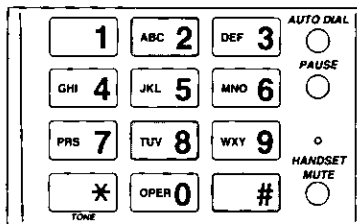

Press #, then press **28** to start programming.

```

TX SPEED=9600BPS[A]
[1.A 2.B 3.C 4.D]
    
```

3

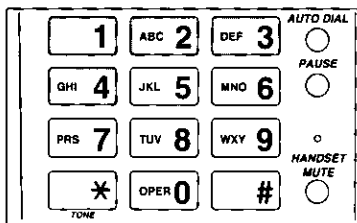

Enter the number of the selection you desire.

- Setting selections:
- 1: A (9600 BPS)
 - 2: B (7200 BPS)
 - 3: C (4800 BPS)
 - 4: D (2400 BPS)

4

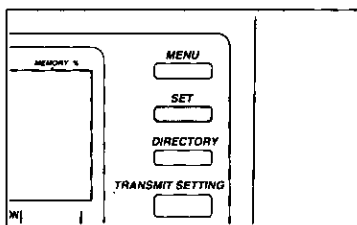

Press **SET** to store your selection into memory.

```

PROG. [1.DATE 2.TEL
3.SYSTEM 4.REPORT]
    
```

5

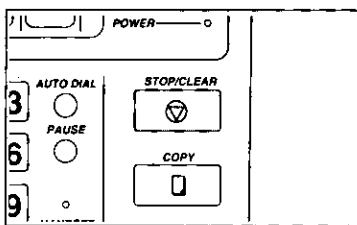

Press **STOP/CLEAR** to end the operation.

4

Setting the Message Alert

When the unit cannot print out the received documents and the memory reception has occurred because of the trouble, the unit will let you know with an alert that the documents have been stored into memory. When you hear slow beeps, clear the printing trouble, and then print out the documents. The beep sounds will stop after printing.

This feature is activated as a pre-selected setting.
If you wish to set this feature off, proceed as follows:

1

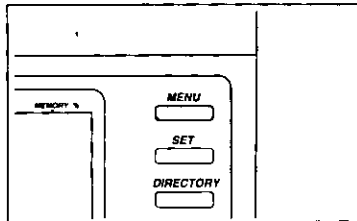

Press **MENU** until the following is shown.

PROG. [1.DATE 2.TEL
3.SYSTEM 4.REPORT]

2

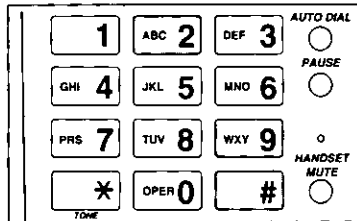

Press #, then press **29**.

MESSAGE ALERT
=ON [1.ON 2.OFF]

3

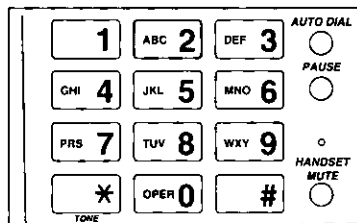

Press **2** to de-activate this feature.

MESSAGE ALERT
=OFF [1.ON 2.OFF]

- Press **1** to activate this feature.

4

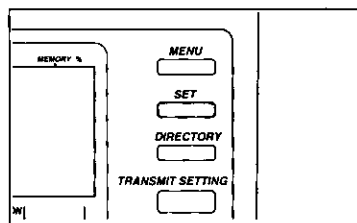

Press **SET** to store your selection into memory.

PROG. [1.DATE 2.TEL
3.SYSTEM 4.REPORT]

5

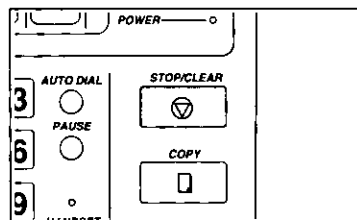

Press **STOP/CLEAR** to end the operation.

Resetting the System Programming Features

Use this operation to return the basic features (#04 to #06) and the advanced features to their initial settings (see pages 30 to 32). The basic features #01 to #03 will still remain programmed even after activating this feature.

1

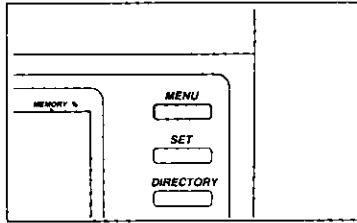

Press **MENU** until the following is shown.

PROG. [1.DATE 2.TEL
3.SYSTEM 4.REPORT]

2

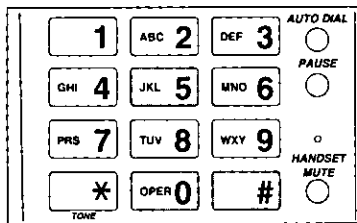

Press #, then press **50** to start programming.

SET DEFAULT
=NO [1.YES 2.NO]

3

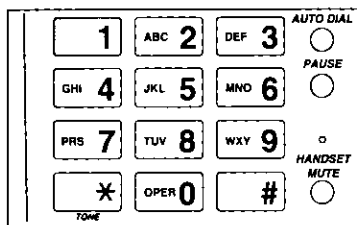

Press **1** to activate this feature.

SET DEFAULT
=YES [1.YES 2.NO]

- To cancel this feature, press **2**.

4

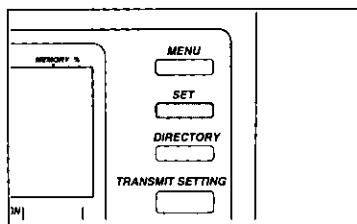

Press **SET** to store your selection into memory.

PARAMETER RESET OK?
=NO [1.YES 2.NO]

5

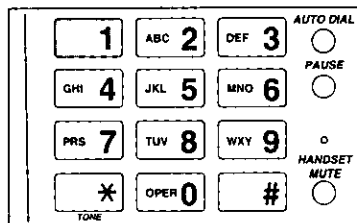

Press **1** to activate this feature.

PARAMETER RESET OK?
=YES [1.YES 2.NO]

- To cancel this feature, press **2**.

6

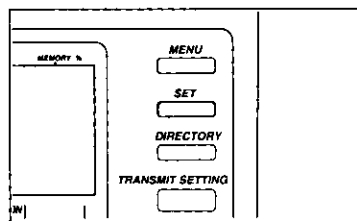

Press **SET** to start resetting.

DEFAULT SETTING
COMPLETED!

(continued)

4

7

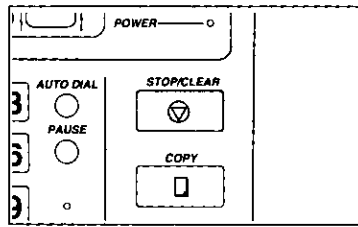

Press **STOP/CLEAR** to end the operation.

Printing the System Programming List

By printing out the list, you can confirm the current settings of the basic and advanced features. To print out, see page 144.

Sample of the system programming list:

```
***** < SYSTEM SET UP LIST > *****
* << BASIC FEATURE LIST >> *
* #01 SET DATE = Aug. 10 1994 04:35PM *
* #02 YOUR LOGO (I.E. COMPANY OR INDIVIDUAL NAME) *
* = ABC Ltd. *
* #03 YOUR TELEPHONE NUMBER = 0123 456 7890 *
* #04 PRINT TRANSMISSION REPORT = ERROR (1=ERROR 2=ON 3=OFF) *
* #05 MEMORY XMT = OFF (1=ON 2=OFF) *
* #06 FAX RING COUNT = 1 (1...4) *
* *
* << ADVANCED FEATURE LIST >> *
* #10 LOGO POSITION = OUT (1=OUT 2=IN) *
* #11 JOURNAL AUTO PRINT = AUTO (1=AUTO 2=MANUAL) *
* #12 NETWORK PASSCODE = 0000 *
* #13 TX PASSCODE CHECK = OFF (1=ON 2=OFF) *
* #14 RX PASSCODE CHECK = OFF (1=ON 2=OFF) *
* #15 POLLING PASSCODE = 0000 *
* #16 SILENT FAX RECOGNITION RING = 3 (3...8) *
* #18 ENTER MESSAGE D *
* A = *** CONFIDENTIAL *** *
* B = *** URGENT REPLY REQUEST *** *
* C = *** URGENT PLEASE READ *** *
* D = *
* #19 COPY MODE = REDUCTION (1=REDUCTION 2=INHIBITION 3=EXTEND) *
* #20 RX REDUCTION = REDUCTION2 (1=REDUCTION1 2=REDUCTION2 3=INHIBITION) *
* #21 FAX FORWARDING = OFF (FAX NO. = ) *
* #23 RING PATTERN DETECTION = OFF (1=A 2=B 3=C 4=D 5=OFF) *
* #24 LCD CONTRAST = NORMAL (1=LIGHT 2=NORMAL 3=DARKER) *
* #27 TEL/FAX DELAYED RING = 1 (1...4) *
* #28 TX SPEED = 9600BPS(A) (1=A 2=B 3=C 4=D) *
* #29 MESSAGE ALERT = ON (1=ON 2=OFF) *
* #50 SET DEFAULT = NO *
* #9000* (SERVICE DATA SET UP) *
* *
* << DELAYED XMT >> *
* DELAYED MODE = OFF *
* MEMORY XMT = ON *
* PHONE NUMBER = *
* START TIME = 12:00AM *
* PAGE COUNTER = 0 *
* MESSAGE OUT = OFF *
*****
```

NOTE:

– The program number “#9000*” is only for service personnel.

To print the system programming list, proceed as follows:

1

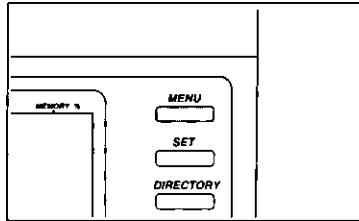

Press **MENU** until the following is shown.

PROG. [1.DATE 2.TEL
3.SYSTEM 4.REPORT]

2

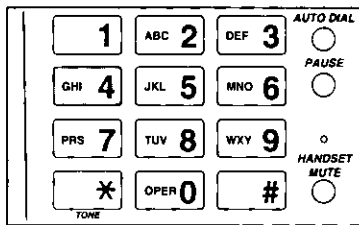

Press **4** to start programming.

SELECT NO. [1:SYSTEM
2.TEL NO. 3.JOURNAL]

3

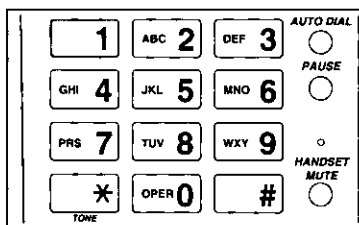

Press **1** to print the list.

The unit starts printing.

PRINTING
SYSTEM LIST

– To interrupt printing, press **STOP/CLEAR** before the unit feeds the paper.

4

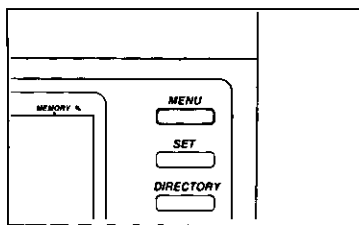

After printing, press **MENU** to end the operation.

Chapter 5

Troubleshooting and Maintenance

Contents

	Page
Troubleshooting	146
Error display messages	146
Explanation of communication result on the report	149
General corrective measures	150
Clearing a document jam	153
Adjusting the feed pressure	154
Clearing a recording paper jam	155
If a Power Failure Occurs... ..	159
Power-down report	159
Maintenance	160
Cleaning the cabinet	160
Cleaning the document feeder unit	160
Cleaning the printer	162
Replacing the cleaning pad and the toner cartridge	163
Replacing the drum unit	169
Repacking	172

Troubleshooting

Error display messages

DISPLAY MESSAGE	CAUSE & SOLUTION
JAN 1 12:00AM 00 CALL SERVICE E1~4	<ul style="list-style-type: none">• Printing system is abnormal. Open and close the cartridge compartment cover. If this message still appears, service call will be required. See page 189.
JAN 1 12:00AM 00 *** CHANGE DRUM ***	<ul style="list-style-type: none">• The drum unit has reached its life expectancy. Replace it with a new one. See page 169.• Once this message has been displayed, the unit can print approximately 50 more pages.
JAN 1 12:00AM 00 <> CHECK DOCUMENT >>	<ul style="list-style-type: none">• The document has not been fed into the unit properly, or the document is electrostatically charged. Re-insert the document. If the misfeeding happens frequently, adjust the feed pressure in the document feeder unit. See page 154.
JAN 1 12:00AM 00 *** CHECK DOOR ***	<ul style="list-style-type: none">• The cartridge compartment cover is open. Close it.
JAN 1 12:00AM 00 CHECK DOOR OR DRUM	<ul style="list-style-type: none">• The printer cover is open. Close it.• The drum unit is not installed properly. Check it and re-install. See page 19.
JAN 1 12:00AM 00 CHECK FAX FORWARDING	<ul style="list-style-type: none">• Documents that could not be forwarded remain in memory. Retrieve them by pressing the MENU button and then the SET button. See page 104.
JAN 1 12:00AM 00 *** CHECK MEMORY ***	<ul style="list-style-type: none">• Memory (the stored phone numbers, parameters, etc.) has been erased. Re-program them.
CHECK PAPER SIZE PRESS MENU KEY	<ul style="list-style-type: none">• The unit has been set to print on legal-size paper but letter size paper has been installed in the paper cassette. Replace the paper in the cassette with legal-size paper, then press the MENU button and then the SET button to print. If you change the paper size setting by pressing the LEGAL PAPER SUPPLY button, the first page in memory will not be printed.
CHECK PAPER SIZE PRESS STOP/CLEAR	<ul style="list-style-type: none">• The unit has been set to print on legal-size paper but letter-size paper has been installed in the paper cassette. Replace the paper in the cassette with legal-size paper or change the paper size setting by pressing the LEGAL PAPER SUPPLY button, then press the STOP/CLEAR button and then try again.

DISPLAY MESSAGE

CAUSE & SOLUTION

```
JAN 1 12:00AM 00
.. DRUM LIFE OVER ..
```

```
DUE TO POWER OFF
DELAYED MODE ABORTED
```

```
INSERT DOCUMENT
FACE DOWN
```

```
JAN 1 12:00AM 99
*** MEMORY FULL ***
```

```
JAN 1 12:00AM 00
*** OUT OF PAPER ***
```

```
JAN 1 12:00AM 00
* PAPER JAM 1 *
```

```
JAN 1 12:00AM 00
* PAPER JAM 2 *
```

```
JAN 1 12:00AM 00
* PAPER JAM 3 *
```

- The drum unit is completely worn out. Replace it with a new one. See page 169.
- The programmed delayed transmission has been cleared due to a power failure or because the power switch has been turned off. Re-program it and try again. See page 81.
- No document is set in the document feeder tray. Insert document properly.
- When performing multistation or memory transmission, the document is too large and exceeds the memory capacity of the unit. Transmit the entire document at a later time or cancel memory transmission (see page 93) and transmit the entire document by using manual or automatic transmission.
- The memory is full of received documents that have been stored in memory due to a lack of recording paper or a recording paper jam. Supply paper to the cassette or clear the jam to print the documents. See page 22 or 155.
- The unit has run out of recording paper. Supply paper. See page 22.
- The paper cassette is not installed properly. Check it and re-install. See page 22.
- The recording paper is jammed in the paper feed area. Remove the paper causing the problem. See page 156.
- The recording paper is jammed in the paper transfer area or the fuser area. Remove the paper causing the problem. See page 156.
- The recording paper is jammed in the paper ejection area. Remove the paper causing the problem. See page 158.

DISPLAY MESSAGE**CAUSE & SOLUTION**

```
JAN 1 12:00AM 00
** POLLING ERROR **
```

- The polling passcode does not match. Check the other party and set the same passcode as the other unit. See page 88.

Note that polling by using the passcode is effective between the compatible machines.

- The other unit does not provide the polled function. Check the other party.

```
JAN 1 12:00AM 00
REDIAL TIME OUT
```

- The automatic redialing was not successful due to a busy line or no answer from the other party. Try again.

```
JAN 1 12:00AM 00
. REMOVE DOCUMENT .
```

- A document is jammed. Open the upper cover and remove the document causing the problem. See page 153.

- The unit attempted to transmit a document longer than 660 mm (26"). Press the STOP/CLEAR button and remove the document. Divide it into two or more pages, and try again.

```
JAN 1 12:00AM 00
*** SUPPLY TONER ***
```

- Toner supply is low. Replace the toner cartridge with a new one. See page 163.

Once this message has been displayed, the unit can print approximately 50 more pages.

```
JAN 1 12:00AM 00
*** TONER EMPTY ***
```

- Toner supply is completely consumed. Replace the toner cartridge with a new one. See page 163.

```
JAN 1 12:00AM 00
.. TRANSMIT ERROR ..
```

- A transmission error has occurred. Try again.
- Your network passcode does not correspond to the other party's. Check the network passcode. See page 96.
- The polling passcode does not match. Check the other party and set the same passcode as the other unit. See page 88.
Note that polling by using the passcode is effective between the compatible machines.

```
JAN 1 12:00AM 00
WAITING TO PRINT
```

- The unit has run out of recording paper while printing. Supply paper. See page 22.
- The recording paper jammed while printing. Remove the paper causing the problem. See page 155.

```
JAN 1 12:00AM 00
*** WARM UP ***
```

- The printer is warming up. Wait until warm-up is completed.

Explanation of communication result on the report

When trouble occurs, the following messages may be printed on the transmission and journal reports. See pages 120 and 124.

PRINTED MESSAGE	MEANING
ABNORMAL TEMPERATURE	•An abnormal high or low temperature occurred.
COMMUNICATION ERROR	•Transmission or reception error occurred.
DOCUMENT JAMMED	•The document was jammed. Remove the document causing the problem. See page 153.
DRUM LIFE OVER	•The drum unit was worn out. Replace the drum unit. See page 169.
MEMORY FULL	•The document was not received due to memory full.
MULTI XMT CANCELED	•Multistation transmission was canceled by pressing the STOP/CLEAR button.
NO DOCUMENT	•The document was not fed into the unit properly.
PAPER OUT	•The unit was out of recording paper. Supply paper. See page 22.
NO RESPONSE	•The receiving unit was busy or out of recording paper.
PASSCODE FAILED	•The passcode communication failed. Check the other party and set the same passcode as the other unit. See pages 88 and 96.
POLLING ABORTED	•Polling was interrupted during the redialing.
PRESSED THE STOP KEY	•Fax communication was interrupted because the STOP/CLEAR button was pressed.
PRINTER PAPER JAM	•The recording paper was jammed. Remove the paper causing the problem. See page 155.
REDIAL TIME OUT	•Transmission was failed because the line was busy or there were no answer.
THE COVER WAS OPENED	•The printer cover was open. Close the cover.
TONER DOOR WAS OPENED	•The cartridge compartment cover was opened. Close the cover.
TONER EMPTY	•Toner supply was completely consumed. Replace the toner cartridge.
XMT ABORTED	•Transmission was interrupted during the redialing.
OK	•Fax communication was successful.

General corrective measures

GENERAL

PROBLEM	CAUSE & SOLUTION
The unit does not operate properly.	<ul style="list-style-type: none">• Turn the power switch off, then turn it on again.• Disconnect the unit from the telephone line and connect a known working phone. If the known working phone operates properly, call your service center to have the unit repaired. If the known working phone does not operate properly, consult your telephone company.
Cannot transmit, receive a document, or talk.	<ul style="list-style-type: none">• Telephone line cord is connected incorrectly or not connected. Confirm the connection. See page 16.
Cannot make a call.	<ul style="list-style-type: none">• Confirm your line condition and set the dialing mode selector properly. See page 26.
The ALARM indicator light is on.	<ul style="list-style-type: none">• The printer cover, cartridge compartment cover, upper or lower cover is open. Close firmly.
The unit does not ring.	<ul style="list-style-type: none">• The ringer volume selector is set in the OFF position. Set the ringer volume selector in the HIGH or LOW position. See page 26.

FAX TRANSMISSION

PROBLEM	CAUSE & SOLUTION
The ALARM indicator light flashes after transmission.	<ul style="list-style-type: none">• A transmission error has occurred. Try again.
The ALARM indicator light is on during transmission.	<ul style="list-style-type: none">• A document more than 660 mm (26") is being transmitted. Divide the document into two or more pages, and try again.• A document is jammed. Remove it, then try again. See page 153.• The unit has received special tones for special telephone services, such as call waiting. Cancel such services, or connect the unit to a line that does not have such services.

PROBLEM	CAUSE & SOLUTION
The other party complains that letters on their received document are distorted.	<ul style="list-style-type: none"> • The unit received special tones for special telephone services, such as call waiting. Cancel such services, or connect the unit to a line that does not have such services. • A reserve telephone connected to the same line was picked up during transmission. Hang up the reserve telephone and try again.
The other party complains that a dirty pattern or black or white lines appear on their received documents.	<ul style="list-style-type: none"> • The glass and rollers inside the document feeder are dirty. Open the upper cover and clean them. See page 160.
Problems when transmitting documents overseas by using the automatic transmission.	<ul style="list-style-type: none"> • Set the overseas transmission mode to on, then try again. See page 107. • Lower the transmission speed, then try again. See page 139. • If you still fail in transmission, transmit with the manual transmission. See page 45.
Misfeeding of documents occurs frequently.	<ul style="list-style-type: none"> • The feed pressure in the document feeder unit is improper. Adjust the pressure. See page 154.

FAX RECEPTION

PROBLEM	CAUSE & SOLUTION
The ALARM indicator light is on during receiving.	<ul style="list-style-type: none"> • The recording paper is jammed. Remove it. See page 155.
Received documents are not printed out and are stored into memory.	<ul style="list-style-type: none"> • The unit ran out of recording paper. Supply paper to print out. See page 22. • The paper cassette is not installed properly. Check it and re-install. See page 22.
Unable to receive documents.	<ul style="list-style-type: none"> • The unit ran out of recording paper, and the memory is full. Supply paper to print documents stored into memory. See page 22. • The paper cassette is not installed properly, and the memory is full. Check it and re-install. See page 22.
Unable to receive documents automatically.	<ul style="list-style-type: none"> • The receiving mode is set to the <i>TEL</i> mode. Operate the manual reception (see page 48) or set the receiving mode to the <i>TEL/FAX</i> or <i>FAX</i> mode. See page 28. • The time to answer the call may be too long. Decrease the number of rings to answer. See pages 122 and 127.

PROBLEM	CAUSE & SOLUTION
Recorded image is faint and cannot be read.	<ul style="list-style-type: none"> • The sender transmitted a faint document. Request the sender to transmit a clearer copy of the document.
Received image is distorted.	<ul style="list-style-type: none"> • The unit has received tones for special telephone services, such as call waiting. Cancel such services, or connect the unit to a line that does not have such services. • A reserve telephone connected to the same line was picked up during reception. Hang up the reserve telephone, and ask the sender to transmit the document again.
A dirty pattern or black lines appear on the received documents.	<ul style="list-style-type: none"> • The rollers inside the printer are dirty. Clean the rollers (see page 162). • There are scratches on the drum unit. Replace the drum unit. See page 169.
Paper jam occurs successively.	<ul style="list-style-type: none"> • The selected paper size is different from the loaded paper's size. Select the correct paper size by pressing the LEGAL PAPER SUPPLY button. See page 29.
Unable to retrieve a document by using the polling function.	<ul style="list-style-type: none"> • Your polling passcode does not correspond to that of the other unit. Program the correct passcode. See page 88. • The other unit does not provide polled function. Check the other party, and try again.

COPYING

PROBLEM	CAUSE & SOLUTION
The ALARM indicator light is on during copying.	<ul style="list-style-type: none"> • The recording paper is jammed. Remove it. See page 155.
A dirty pattern or black lines appear on the copied documents.	<ul style="list-style-type: none"> • The rollers inside the printer are dirty. Clean the rollers see page 162. • There are scratches on the drum unit. Replace the drum unit. See page 169.
Misfeeding of documents occurs frequently.	<ul style="list-style-type: none"> • The feed pressure in the document feeder unit is improper. Adjust the pressure. See page 154.

Clearing a document jam

If an original document becomes jammed in the document feeder unit, the alarm indicator will light and the display will show the following message:

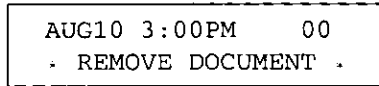

Remove the document causing the problem by proceeding as follows:

NOTE:

– Do not turn off the power when clearing a paper jam, or the stored documents will be erased.

1

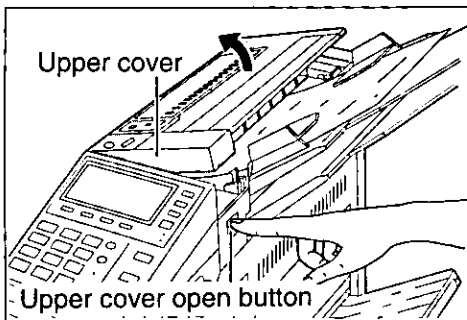

Open the upper cover by pushing the upper cover open button.

2

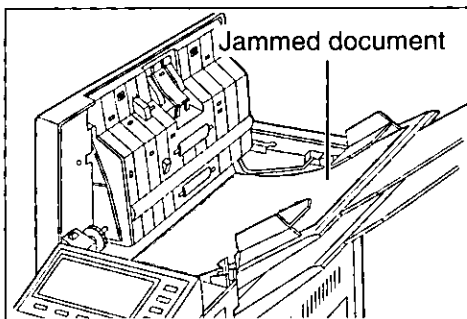

Remove the jammed document carefully.

3

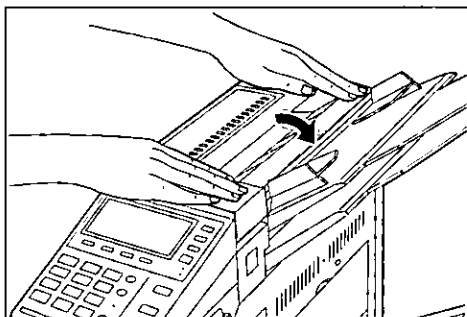

Close the upper cover carefully by pushing down until the cover locks into position.

Adjusting the feed pressure

If misfeeding of documents, such a multiple feed trouble or no feed trouble, occurs frequently, try to adjust the feed pressure in the document feeder unit by proceeding as follows:

1

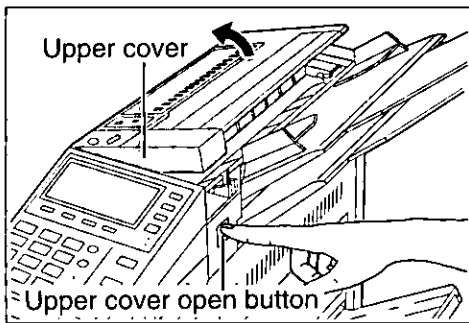

Open the upper cover by pushing the upper cover open-button.

2

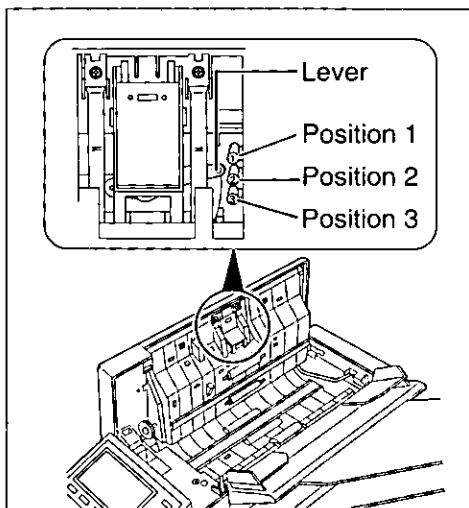

Shift the position of the lever on the document feeder unit by using an instrument with a pointed end, like a clip or ball-point pen.

Position 1: The case of no feed trouble

Position 2: Standard position

Position 3: The case of multiple feed trouble

3

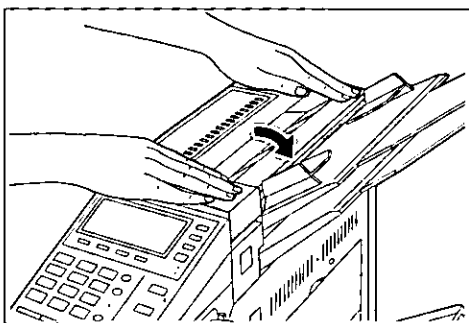

Close the upper cover carefully by pushing down until the cover locks into position.

Clearing a recording paper jam

If a recording paper jam occurs inside the unit, the display will show one of the following messages. Check the relevant areas, and remove any jammed paper.

AUG10 3:00PM	00
* PAPER JAM 1	*

.....Paper feed area. See page 156.

AUG10 3:00PM	00
* PAPER JAM 2	*

.....Paper transfer area or fuser area. See page 156.

AUG10 3:00PM	00
* PAPER JAM 3	*

.....Paper ejection area. See page 158.

CAUTION:

– The fuser unit gets hot. Do not touch it.

NOTES:

- Do not turn off the power when clearing a paper jam, or the stored documents will be erased.
- If stains appear on the printed paper after a paper jam is cleared, it is recommended that you copy several pages as test printing.

Paper Jam Areas:

<Cross section>

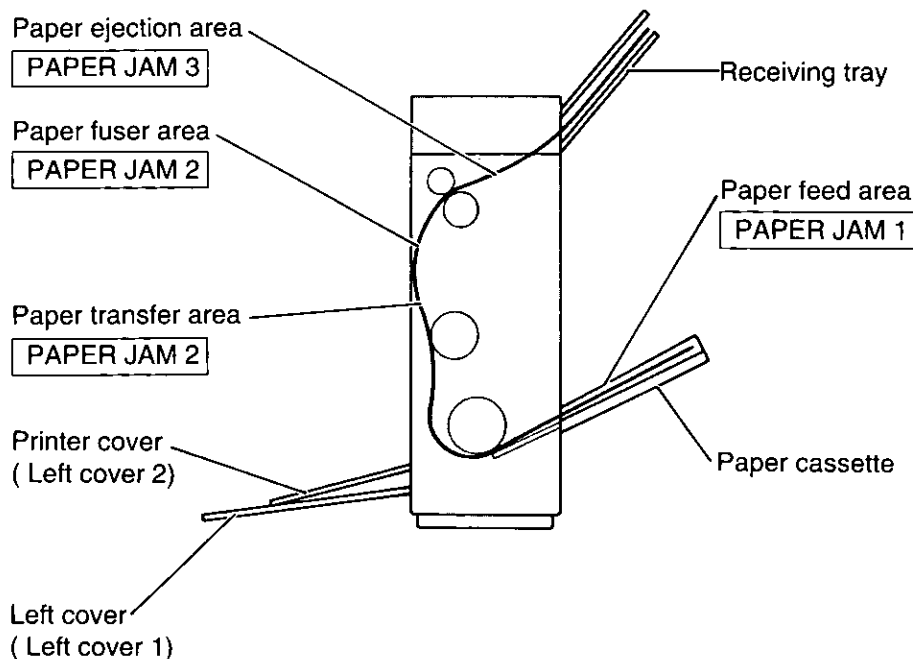

Clearing a paper jam in the paper feed area:

When the display shows the following message, proceed as follows:

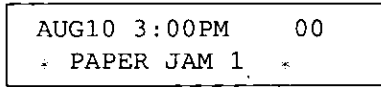

1

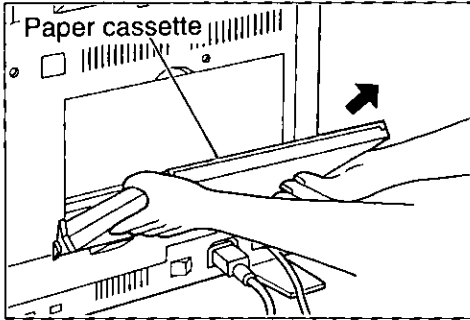

Remove the paper cassette from the unit.

2

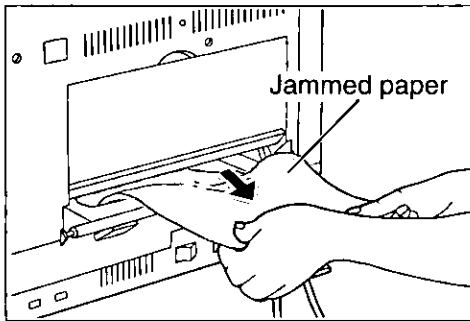

Remove the jammed paper, then re-install the paper cassette.

NOTE:

- After removing the jammed paper, open the left cover and then open and close the printer cover once to clear the error message.

Clearing a paper jam in the paper transfer area or the fuser area:

When the display shows the following message, proceed as follows:

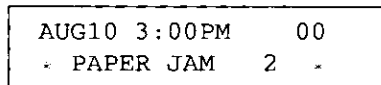

1

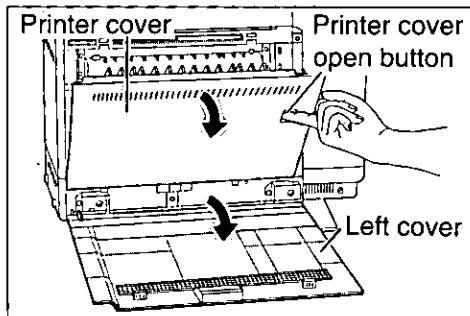

Open the left cover, and open the printer cover by pulling the printer cover open button.

(continued)

2

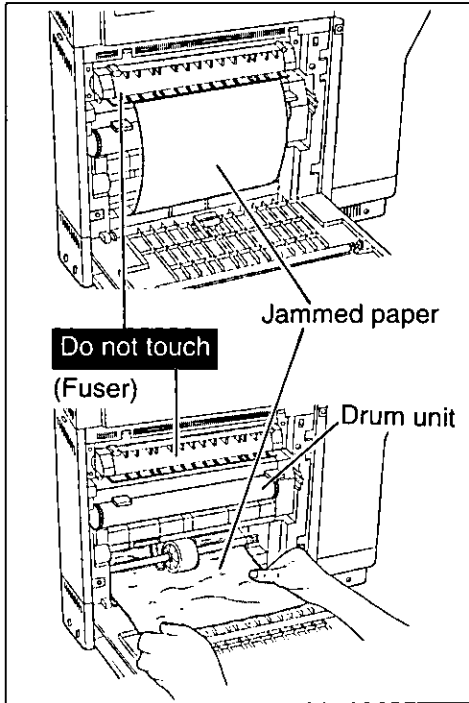

Remove the jammed paper.

CAUTIONS:

- The fuser gets hot. Do not touch it.
- Do not expose the drum unit to light for more than 5 minutes.
- Do not touch the green drum surface.
- If the jammed paper has toner on it, do not pull it out through the paper feed slot.
- Be sure that no paper fragments remain in the printer.

3

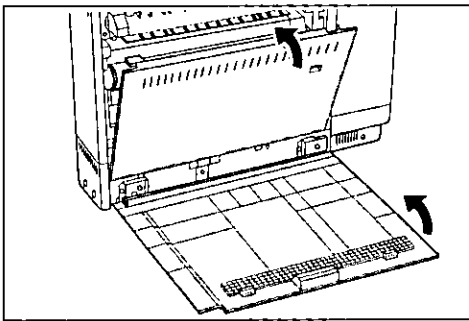

Close the printer cover and left cover.

NOTE:

- If a paper jam still occurs in the fuser area, after performing the above instructions, torn paper may remain in the printer unit. Check the inside of the printer unit.

5

Clearing a paper jam in the paper ejection area:

When the display shows the following message, proceed as follows:

AUG10 3:00PM 00
> PAPER JAM 3 <

1

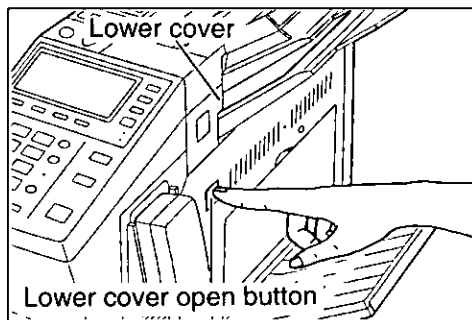

Push the lower cover open button, and open the lower cover completely until it clicks.

2

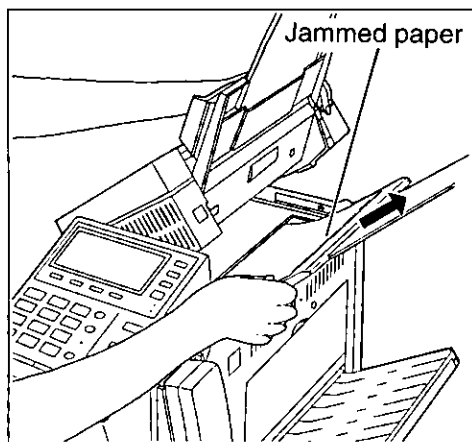

Remove the jammed paper by carefully pulling it up.

3

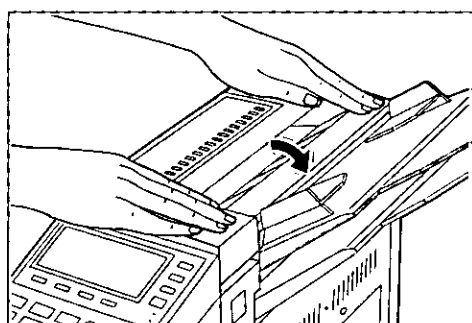

Close the lower cover carefully by pushing down until the cover locks into position.

NOTE:

– If the jammed paper is not found in the paper ejection area, check the paper transfer area or the fuser area (see page 156).

If a Power Failure Occurs...

This unit does not work if a power failure occurs. You cannot make and answer calls during a power failure. If a power failure occurs while transmitting or receiving documents, the transaction will be interrupted, and the document information stored into memory will be lost. Try again after the power is restored.

NOTE:

- If a reserve phone is connected to the same line, use it during a power failure.

Power-down report

The power-down report will automatically print out after the power is restored.

This report will tell which stored documents have been lost.

The report will not print out when there are no documents stored into memory.

Sample of the power-down report:

```
***** POWER DOWN REPORT *****
*
*                               POWER DOWN AT:      AUG. 10. 1994  4:23 PM
*
*                               RESTARTED AT:       AUG. 10. 1994  4:32 PM
*
*
*                               << WARNING >>
*                               CONTENTS HAVE BEEN CLEARED DUE TO POWER DOWN.
*
*
*-----
*  No.   OTHER FACSIMILE   START TIME   TX PAGES   FUNCTION
*-----
*  01   9876543           11:45AM     02        DELAYED TRANSMISSION
*
*
*
*
*-----
*****
```

NOTES:

- The programmed information, such as system programming features and the stored phone numbers will remain in memory during the power failure because of the back up, built-in lithium battery.
- When the fax forwarding feature is on, the power-down report will be transmitted to the forwarding station after the power is restored (see page 101).

Maintenance

If there is a trouble on image quality, it will be required to clean the portions causing the trouble. Even if there is no trouble, periodic cleaning is recommended. The frequency of cleaning is depending on the environment.

Refer to below:

- We recommend that you clean the unit at least once a month.
- When a dirty pattern or black or white bands appear on a copied or transmitted document, clean the document feeder unit. See below.
- When the document is not fed properly, clean the document feeder unit. See below.
- When dark stripes or toner stains appear on printed paper, clean the printer. See page 162.

CAUTION:

- If the unit has documents in memory, retrieve them before performing maintenance. See pages 52 and 104. Then turn the power off before performing any maintenance.

Cleaning the cabinet

Use only a soft and dry cloth to clean the cabinet.

CAUTION:

- Do not use benzine, thinner, aerosol cleaners, or any abrasive powder to clean the cabinet.

Cleaning the document feeder unit

Clean the inside of the document feeder unit by proceeding as follows;

- when a dirty pattern or black or white bands appear on a copied or transmitted document.
- when the document is not fed properly.

1

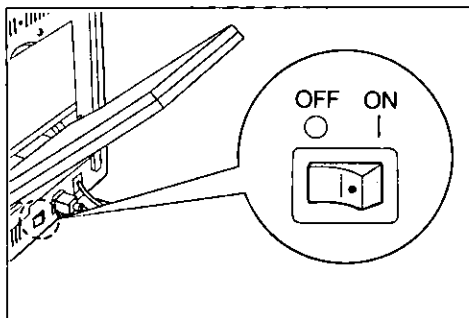

Turn the power off after confirming there is no document in memory.

2

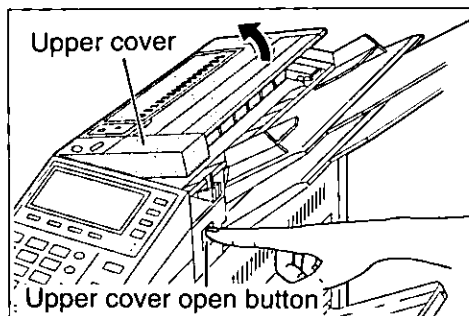

Open the upper cover by pushing the upper cover open button.

(continued)

3

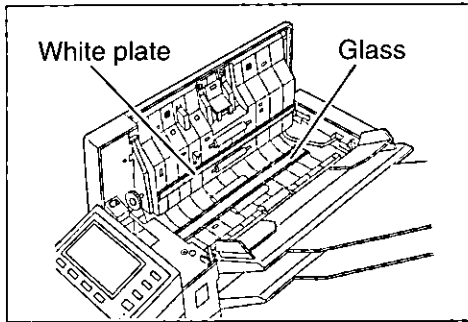

Wipe the glass and the white plate with a dry soft cloth.

4

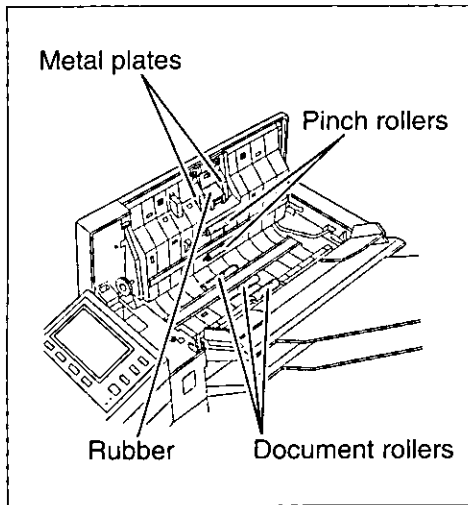

Clean the document rollers, pinch rollers, and rubber with a cloth moistened with isopropyl rubbing alcohol, then dry thoroughly to prevent paper from jamming.

NOTES:

- To prevent malfunction due to static electricity, do not use a dry cloth.
- Do not push the metal plates to avoid bending.

5

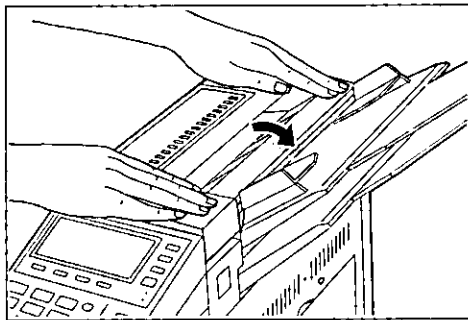

Close the upper cover carefully by pushing down until the cover locks into position.

5

Cleaning the printer

If dark stripes or toner stains appear on printed pages, clean the inside of the printer by proceeding as follows:

1

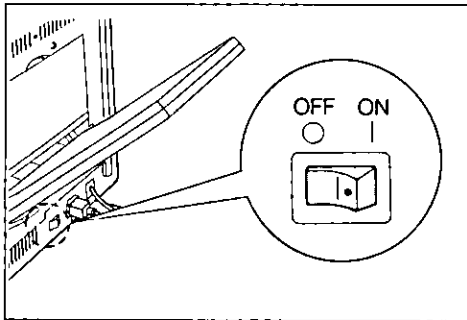

Turn the power off after confirming there is no document in memory.

– Before cleaning the inside of the printer, allow the unit to cool (about 5 minutes).

2

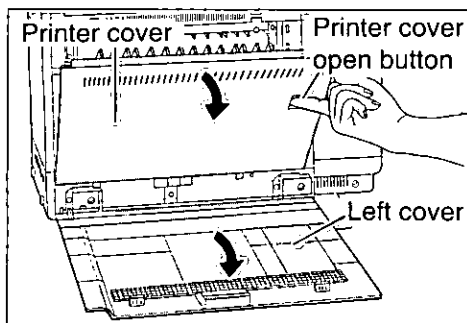

Open the left cover, and open the printer cover by pulling the printer cover open button.

3

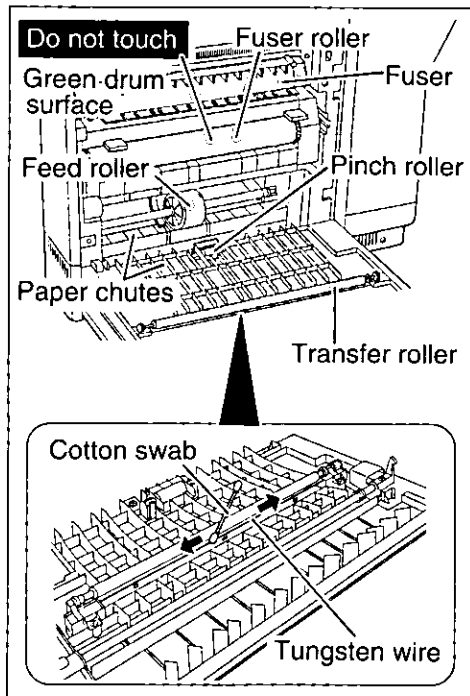

Clean the following areas with a dry soft cloth:

- Pinch roller
- Feed roller
- Transfer roller
- Paper chutes (paper dust)

Then, carefully wipe the tungsten wire by sliding a cotton swab from end to end 4 to 5 times.

CAUTIONS:

- The unit must be turned off prior to cleaning.
- Do not clean the fuser with a stiff material. It may damage the fuser roller.
- Do not expose the drum unit to light for more than 5 minutes.
- Do not touch the green drum surface.

(continued)

4

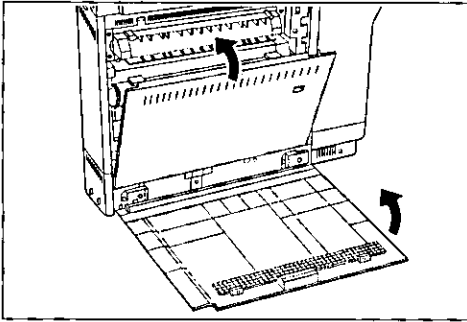

Close the printer cover and left cover firmly.

Replacing the cleaning pad and the toner cartridge

When the toner decreases to a level requiring replacement, the display will show the following message. Install a new toner kit (Part No. PPX-T001), which contains a toner cartridge and a cleaning pad.

```
AUG10 3:00PM 00  
... SUPPLY TONER ...
```

or

```
AUG10 3:00PM 00  
... TONER EMPTY ...
```

CAUTION:

– If ingestion of toner occurs, drink several glasses of water to dilute stomach contents, and seek immediate medical treatment. If eye contact with toner occurs, flush thoroughly with water, and seek medical treatment. If skin contact with toner occurs, wash thoroughly with soap and water.

NOTE:

– Do not replace the toner cartridge until the message “SUPPLY TONER” or “TONER EMPTY” is displayed.

To replace the cleaning pad and the toner cartridge, follow the instructions on the next page.

5

1

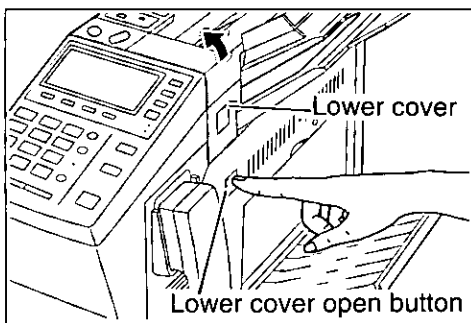

Push the lower cover open button, and open the lower cover completely until it clicks.

2

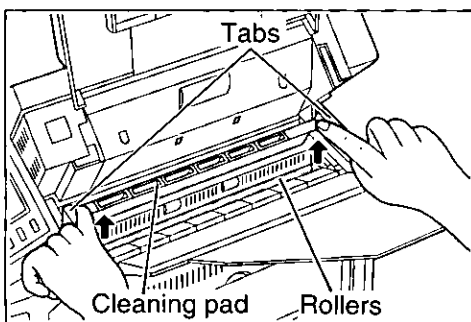

Remove the cleaning pad by lifting both tabs up.

CAUTION:

– Do not touch the rollers under the cleaning pad, because it may be hot.

3

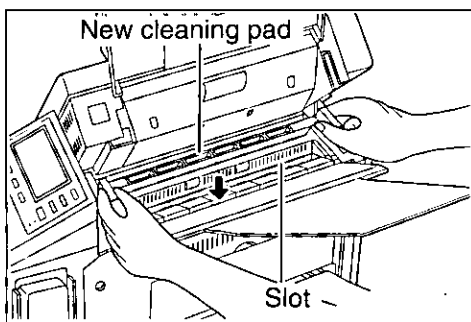

Insert the new cleaning pad into the slot by holding both side tabs.

4

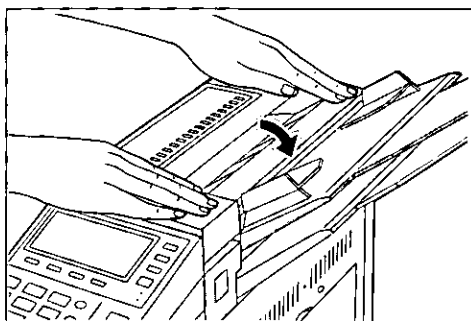

Close the lower cover carefully by pushing down until the cover locks into position.

(continued)

5

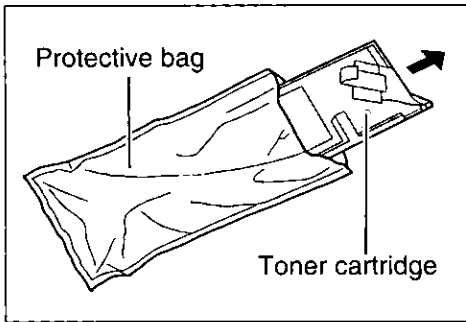

Open the protective bag and remove the toner cartridge.

6

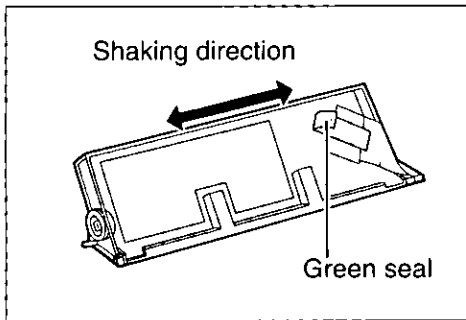

Gently shake the toner cartridge horizontally 4 to 5 times.

– This action distributes the toner evenly.

NOTE:

– Do not peel off the green seal until the installation is completed.

7

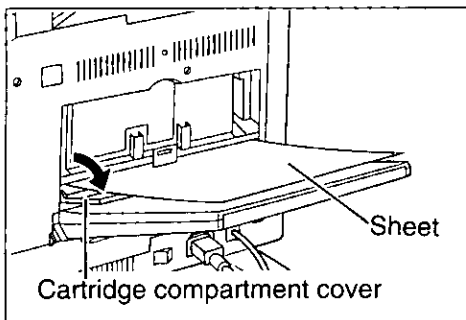

Open the cartridge compartment cover.

CAUTION:

– Place a useless sheet on the opened cartridge compartment cover in order to avoid getting dirty with the toner.

8

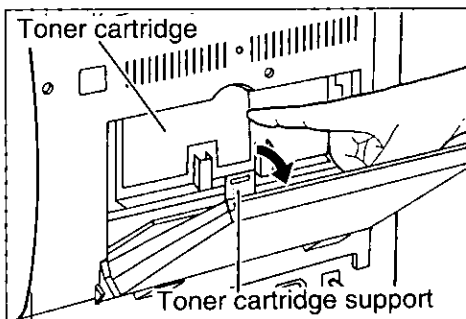

Tap the toner cartridge to empty toner and release the toner cartridge support.

(continued)

5

9

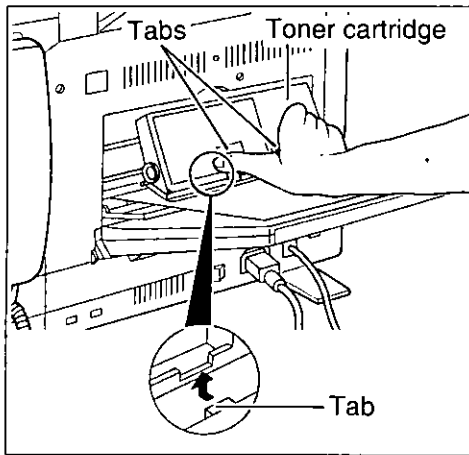

Remove the toner cartridge carefully by pushing both tabs firmly and raising it slightly.

CAUTION:

- Be careful not to spill any residual toner in removed toner cartridge.

10

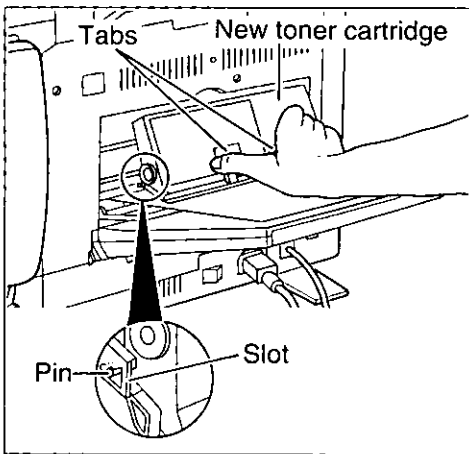

Install the new toner cartridge.

- Hold the tabs on the toner cartridge, and insert the side pins of the toner cartridge into the slots on the developer unit.

11

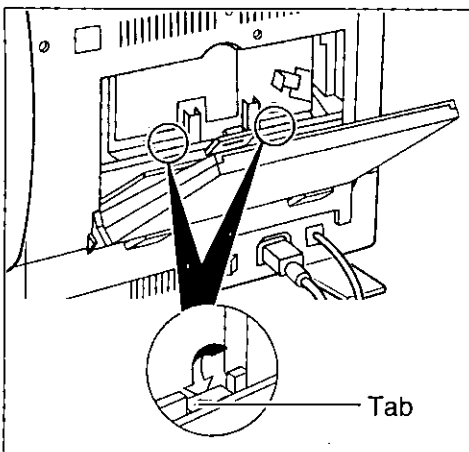

Press the toner cartridge down until it is caught by the tabs.

(continued)

12

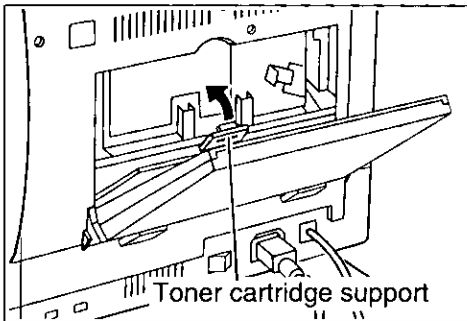

Close the toner cartridge support.

13

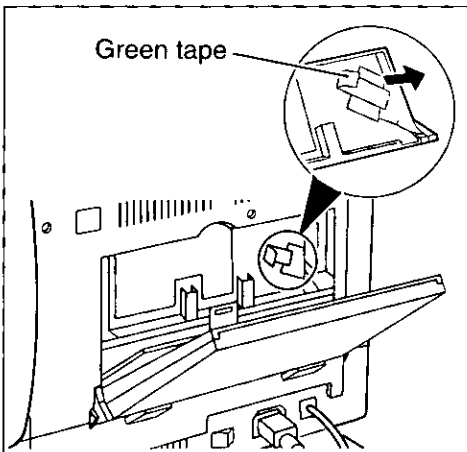

Peel off the green tape.

14

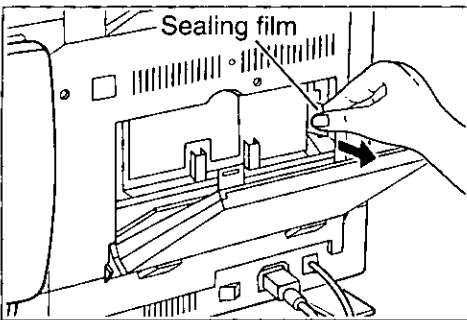

Hold the unit firmly, and completely remove the clear plastic sealing film by grasping it and pulling it outward .

NOTES:

- Do not twist the sealing film while pulling it, because toner may spill over.
- Be careful not to make the surrounding area dirty when handling the sealing film, because it may contain toner residue.

15

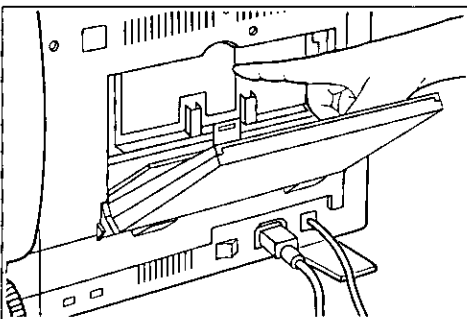

Tap the toner cartridge lightly to empty toner into the developer unit.

(continued)

16

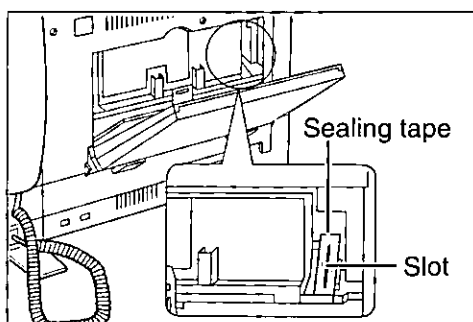

Put and fix the sealing tape to close the slot on the rear side of the toner cartridge.

– Use the provided sealing tape.

17

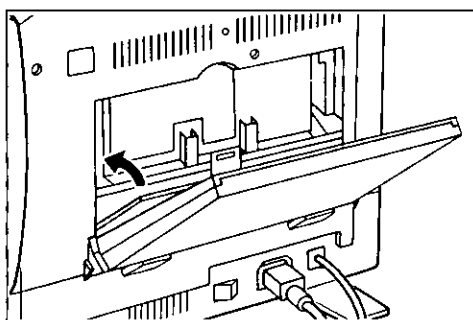

Remove the sheet on the cartridge compartment cover, and close the cover.

(continued)

Replacing the drum unit

When the drum unit is worn out, the display will show the following message. The unit will stop printing after approximately 50 pages. Replace the drum unit with a new one (Part No. PPX-D001).

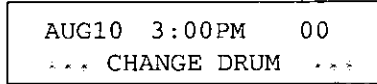

CAUTION:

- The drum unit contains a photosensitive drum. Exposing it to light may damage the drum.
 - Do not expose the drum unit to light for more than 5 minutes.
 - Do not touch the green drum surface.
 - Do not keep the drum unit near dust or dirt.
 - Do not place the drum unit in a high humidity area.
 - Do not expose the drum unit to direct sunlight.

To replace the drum unit, follow the instructions below.

1

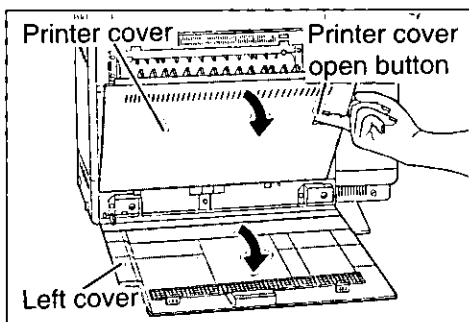

Open the left cover, and open the printer cover by pulling the printer cover open button.

(continued)

2

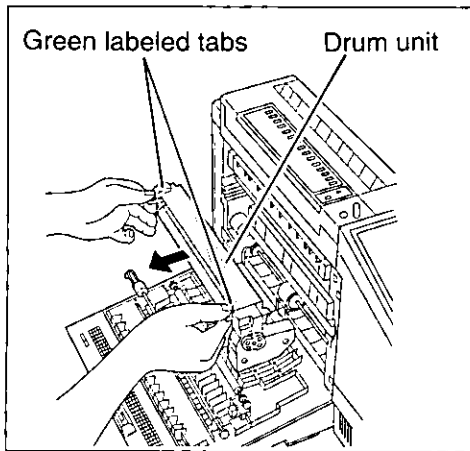

Remove the drum unit by slightly raising both green labeled tabs and pulling the drum unit outward.

3

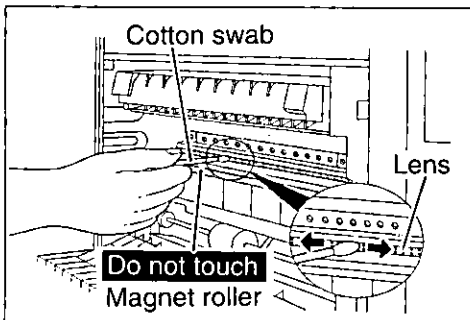

Wipe the lens by sliding the cotton swab from end to end 4 to 5 times.

– It is recommended to clean the inside of the printer (see page 162).

CAUTION:

– Do not touch the magnet roller.

4

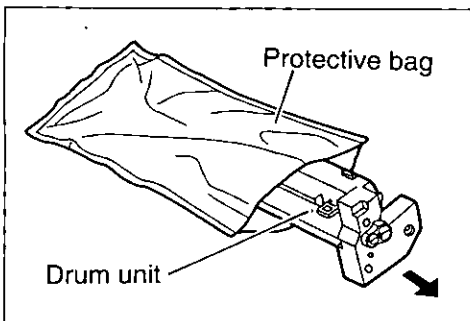

Open the protective bag and take out the drum unit.

5

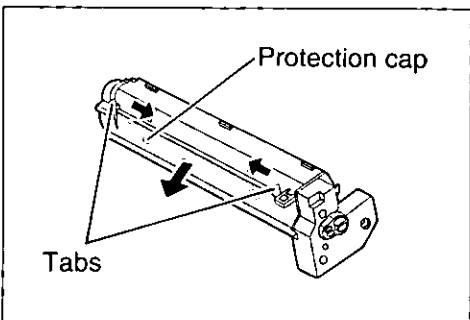

Remove the drum protection cap by pushing the right and left tabs inward.

NOTES:

- Do not touch the green drum surface under the protection cap as it may damage the drum unit.
- Keep the protection cap in the event that the unit must be repacked and transported.

(continued)

6

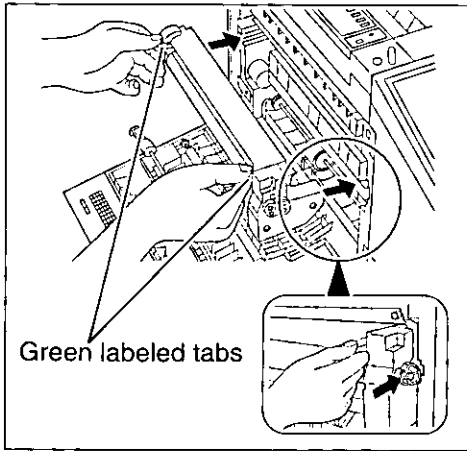

Install the new drum unit by holding the green labeled tabs and pushing it firmly into place.

7

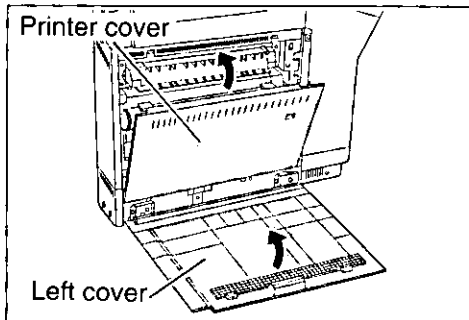

Close the printer cover and left cover firmly.

5

Repacking

To transport or ship your unit, follow the instructions below.

- Disconnect the cords, cassette, and trays.
- Seal the toner cartridge.
- Repack the drum unit.
- Seal the inside of the printer.
- Pack into the original carton.

NOTES:

- Use the original carton and all of the original packing materials.
- Improper repacking of the unit may result in a service charge to repair the unit or in a cleaning charge to remove spilled toner.
- Because the unit uses dry toner, extreme care must be taken when handling. The unit should be handled in the upright (vertical) position until the unit is repacked completely.

Materials Required:

- Original carton and packing materials
- Dropcloth or newspaper
- Shipping tape
- Old clothing or clothing you do not mind getting dirty.

Disconnecting the cords, cassette, and trays:

1

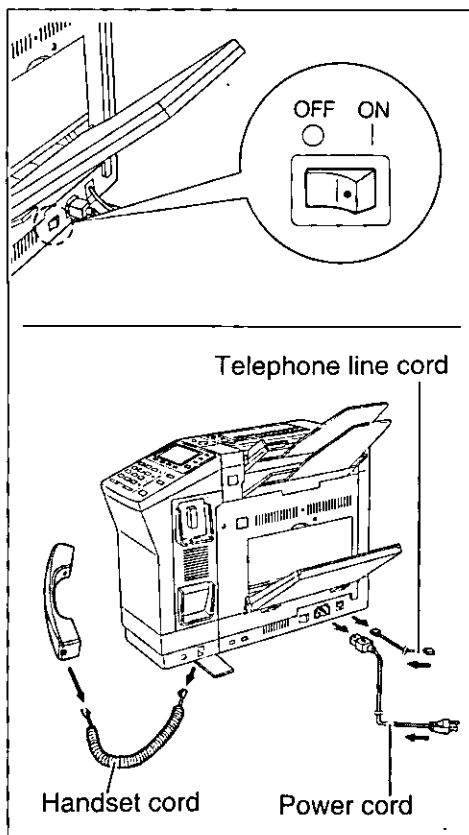

Turn the power off, then disconnect the power cord, telephone line cord, and handset cord.

- To disconnect the telephone line cord and handset cord, pull the plug while pressing the tab on it.

(continued)

2

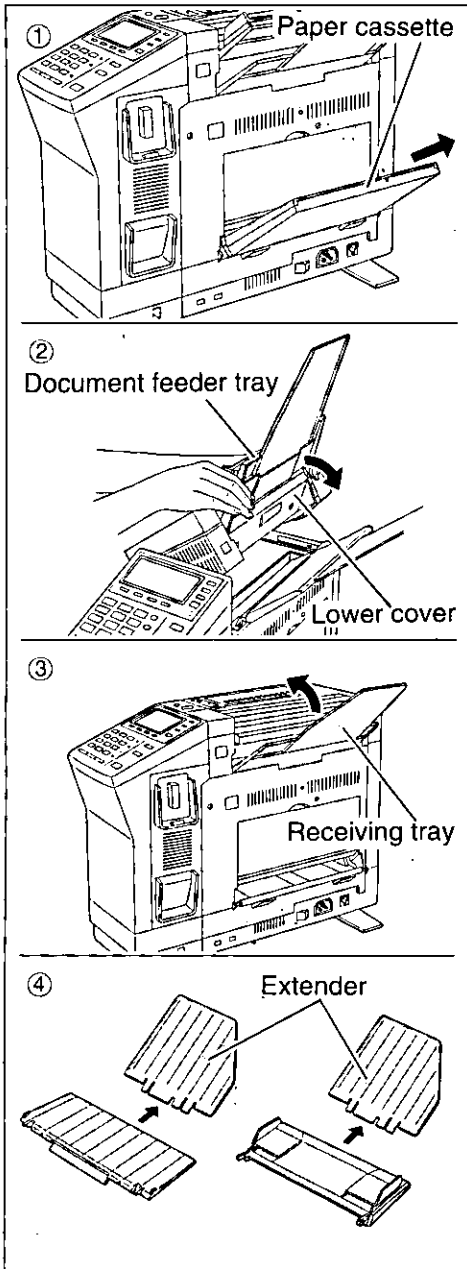

Remove the paper cassette, the receiving tray, and the document feeder tray by proceeding as follows:

- ① Pull the paper cassette outward with holding its both sides and remove it.
- ② Open the lower cover by pushing the lower cover open button. Then hold the lower cover, and push the document feeder tray downward and remove it, and close the lower cover.
- ③ Pull the receiving tray upward and remove it.
- ④ Remove the extenders from the receiving tray and the document feeder tray.

(continued)

Sealing the toner cartridge:

3

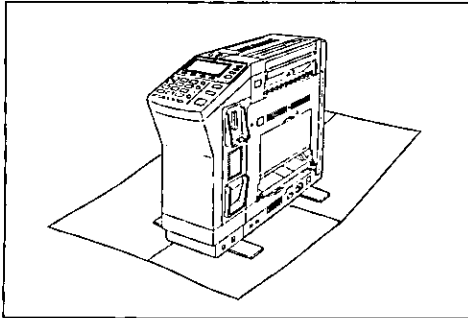

Spread a dropcloth or newspaper under the unit to keep the work area clean.

4

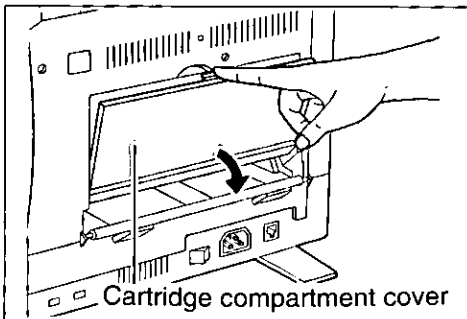

Open the cartridge compartment cover.

5

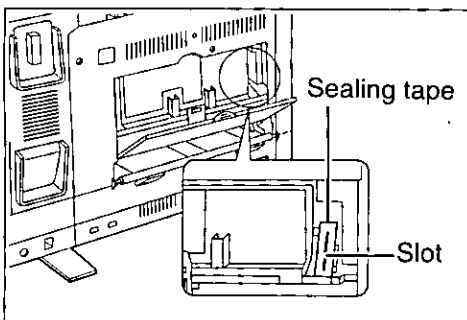

Put and fix the sealing tape to close the slot on the rear side of the toner cartridge if you have not covered the slot.

- Use the provided sealing tape.
- If toner spills around the slot, clean the area.

6

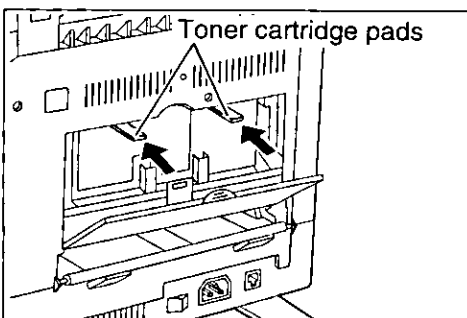

Install the toner cartridge pads.

(continued)

7

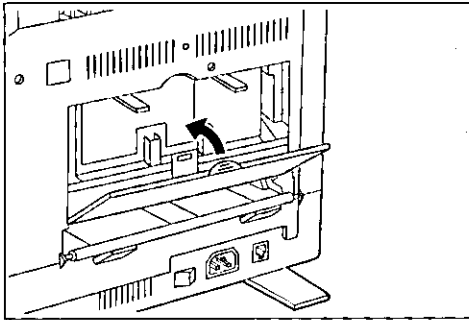

Close the cartridge compartment cover.

Repacking the drum unit:

8

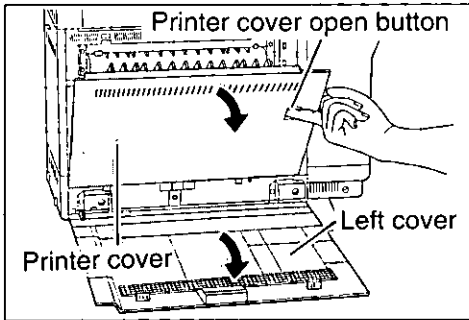

Open the left cover, and open the printer cover by pulling the printer cover open button.

9

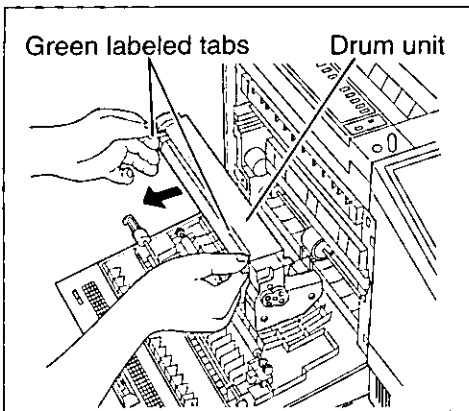

Remove the drum unit by slightly raising both green labeled tabs and pulling the drum unit outward.

CAUTIONS:

- Do not touch the green drum surface.
- Do not transport or ship the unit with the drum unit installed.

10

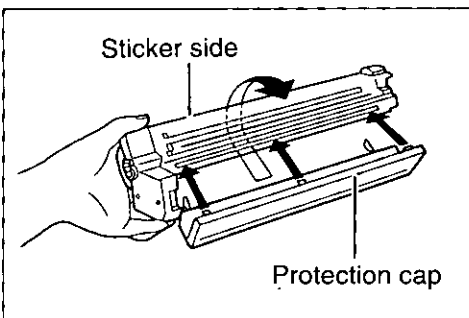

Replace the drum protection cap on the drum unit.

NOTE:

- Always place the drum unit with sticker side facing up, otherwise the printer may not be able to function properly.

(continued)

5

11

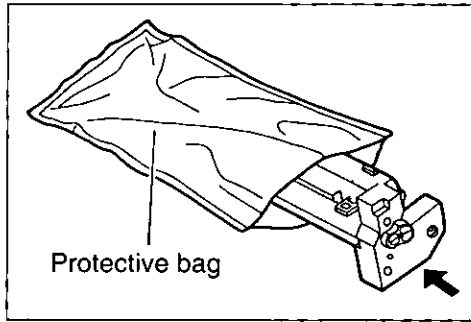

Pack the drum unit into the protective bag.

Sealing the inside of the printer:

12

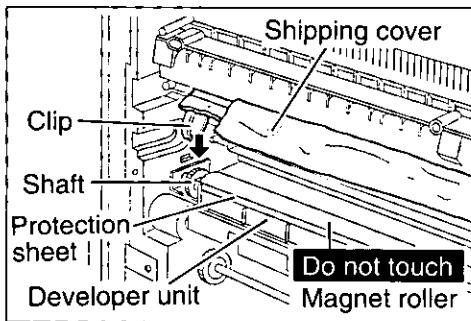

Hook the left clip of the shipping cover on the shaft of the developer unit, and press the clip firmly.

CAUTIONS:

- Do not touch the magnet roller.
- Make sure the protection sheet remains visible while installing the shipping cover.
- Be sure to install the shipping cover properly to avoid spilling toner.

13

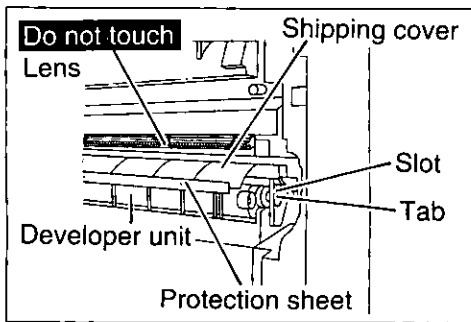

Press the right side of the shipping cover firmly, and insert the tab of the developer unit into the slot until a click into place.

CAUTION:

- Do not touch the lens.

(continued)

14

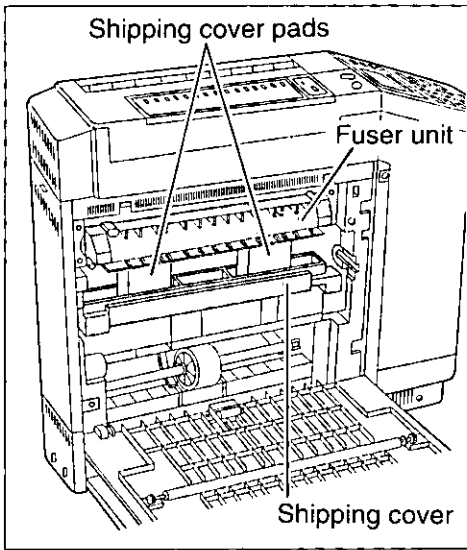

Install the shipping cover pads straight between the shipping cover and the fuser unit.

- The shipping cover pads should be placed in the cutouts on the shipping cover, corresponding to the green labels.

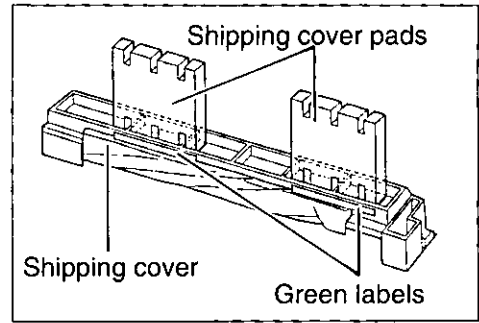

15

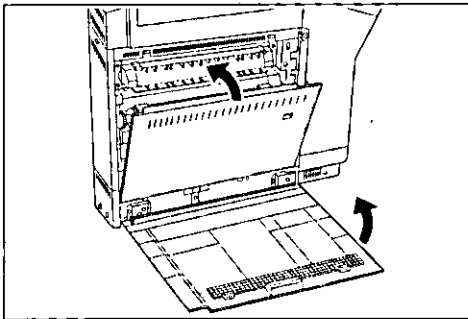

Close the printer cover and left cover firmly.

16

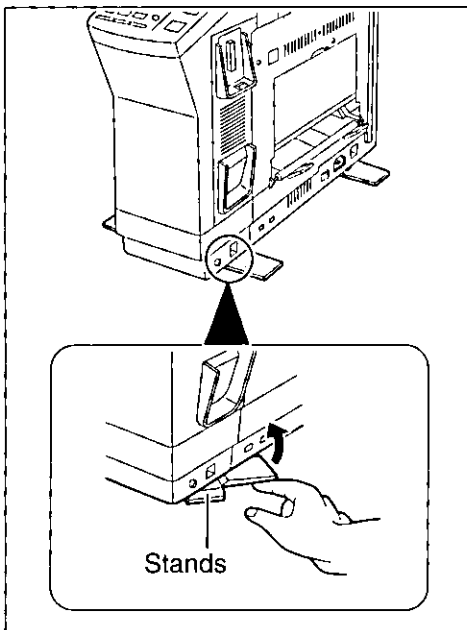

Place all the printer stands in their original positions.

(continued)

Repacking into the original carton:

17

- ① Wrap the unit in the packing sheet.
- ② Install the bottom cushion into the original carton box, and place the unit on it.
- ③ Place the right (R) and left (L) cushions on the unit.
- ④ Place the accessories shown below into the original accessory carton.
- ⑤ Place the accessory carton into the box.
- ⑥ Seal the box with plastic shipping tape.

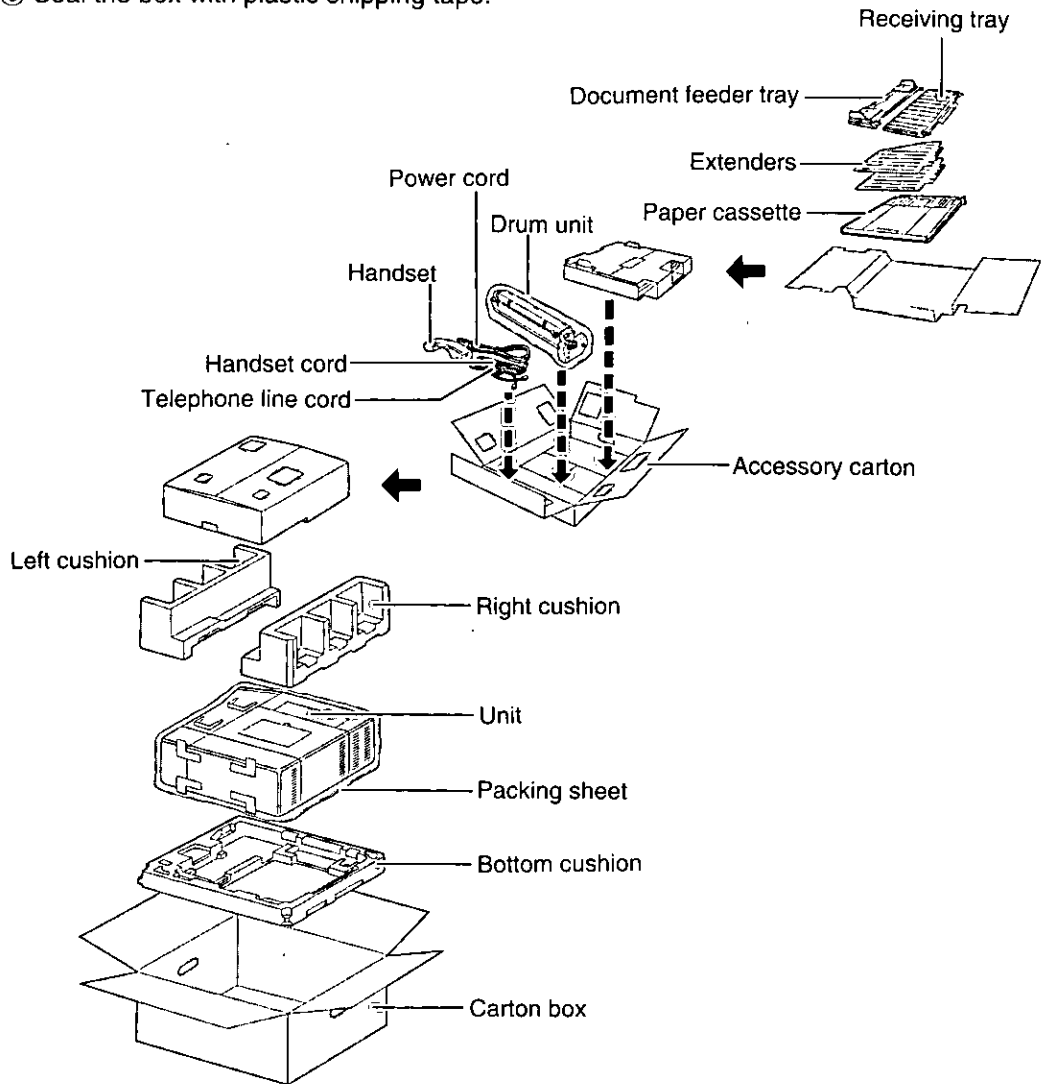

Chapter 6

General Information

Contents

	Page
Accessory Order Information	180
Specifications	181
Main unit specifications	181
Paper specifications	182
Speed Dial Directory	183
Index	185
FCC Information	188
Servicenter Directory	189
Limited Warranty	190



Accessory Order Information

Replacement parts and accessories are available through our local authorized parts distributors.

Part No.	Description	Comment
PPX-T001	Toner kit	Life: Approx. 1,600 pages average* 1 toner cartridge & 1 cleaning pad
PPX-D001	Drum unit	Life: Approx. 6,000 pages average

* In case of 5% image area with multiple copying.

Specifications

Main unit specifications

Item No.	
1. Applicable Lines:	Public switched telephone network
2. Compatibility:	ITU-TS G3
3. Effective Scanning Width:	Max. 208 mm ($8\frac{3}{16}$ ")
4. Recording Paper Size:	Letter: 216 × 279 mm ($8\frac{1}{2}$ " × 11") Legal: 216 × 356 mm ($8\frac{1}{2}$ " × 14")
5. Effective Printing Width:	206 mm ($8\frac{1}{8}$ ")
6. Transmission Time*:	Approx. 30 sec/page (G3 Normal mode, MH) Approx. 17 sec/page (G3 Original mode, MH) Approx. 15 sec/page (G3 Original mode, MR)
7. Fax Redial Times:	Up to 5 times
8. Telephone Redial Times:	Up to 15 times
9. Scanning Density:	Horizontal: 8 pels/mm (203 pels/inch) Vertical: 3.85 lines/mm (98 lines/inch) — Standard mode 7.7 lines/mm (196 lines/inch) — Fine or Halftone mode
10. Scanner Type:	Contact image sensor
11. Printer Type:	Electrophotographic LED array printer
12. Data Compression System:	Modified Huffman (MH), Modified READ (MR)
13. Modem Speed:	9600/7200/4800/2400 bps; Automatic Fallback
14. Operating Environment:	10 – 32.5°C (50 – 90.5°F) 20 – 80% RH
15. Dimensions (H × W × D):	371 × 148 × 489 mm ($14\frac{5}{8}$ " × $5\frac{13}{16}$ " × $19\frac{1}{4}$ ")
16. Mass (Weight):	Approx. 12 kg (26.4 lbs.)
17. Power Consumption:	Standby: 12 – 480 W Transmission: 17 – 490 W Reception: 12 – 480 W Copy: 24 – 500 W Maximum: 600 W

***Transmission Time:**

Transmission times apply to text data using ITU-TS No. 1 test chart, between the same models at maximum modem speed and may vary in actual usage.

NOTE:

– The specifications are subject to change without notice.

Paper specifications

Item No.	
1. Basic Weight:	60 – 120 g/m ² (16 – 24 lbs.)
2. Thickness:	3.7 – 7.5 mils (1 mil= $\frac{1}{1000}$ ")
3. Moisture Content:	4 – 6%
4. Smoothness:	100 – 300 Sheffield
5. Acid Content:	5.5 PH minimum
6. Fusing Compatibility:	Must not scorch, melt, offset material, or release hazardous emissions when heated to 200°C (392°F) for 0.1 second
7. Cutting Dimensions:	±0.0313" of nominal, corners 90°±4°
8. Grain:	Long grain
9. Cut Edge Conditions:	Cut with sharp blades, no paper dust
10. Ash Content:	Not to exceed 10%
11. Curl:	No allowable curl toward side to be imaged.(printed)
12. Packing:	Polylaminated moisture proof ream wrap

Speed Dial Directory

Station No.	Name / Phone No.	Station No.	Name / Phone No.
00		25	
01		26	
02		27	
03		28	
04		29	
05		30	
06		31	
07		32	
08		33	
09		34	
10		35	
11		36	
12		37	
13		38	
14		39	
15		40	
16		41	
17		42	
18		43	
19		44	
20		45	
21		46	
22		47	
23		48	
24		49	

Speed Dial Directory

Station No.	Name / Phone No.	Station No.	Name / Phone No.
50		75	
51		76	
52		77	
53		78	
54		79	
55		80	
56		81	
57		82	
58		83	
59		84	
60		85	
61		86	
62		87	
63		88	
64		89	
65		90	
66		91	
67		92	
68		93	
69		94	
70		95	
71		96	
72		97	
73		98	
74		99	

A

Accessory	180
Advanced features	31
ALARM indicator	13
Amount of spending memory	27
AUTO DIAL button	12, 63, 77, 111
Automatic dialer	75, 111
Making voice calls using	111
Storing phone numbers for	58
Transmitting documents using	75
Automatic reception	49
Automatic redialing feature	46, 47, 56, 75, 111

B

BACK SPACE key	39
Basic features	30
BROADCAST key	14, 61, 76

C

Cartridge compartment cover	11
Character key	12, 14
How to use	37
Cleaning	160
Cabinet	160
Document feeder unit	160
Printer	162
Cleaning pad	164
Replacing	163
Command key	39
Copy	53
Extension copy	130
Making	53
Setting copy mode	128
COPY button	12, 53
Cursor key	39
Customized Header	106
Programming	107, 109

D

Date and time setting	33
Delayed transmission	81
DELETE key	39
DIALING MODE selector	11, 26
Direct call station keys	14, 59, 75, 111
DIRECTORY button	13, 73
Directory card	58
Display	27
Adjusting contrast	136
DISPLAY CLEAR key	39

Document	42, 48
Acceptable	42
Clearing a jam	153
Copying	53
Loading	44
Receiving	48
Receiving over-sized	51
Transmitting	42
Unacceptable	42
Document feeder tray	22
Double sided printing	25
Drum unit	9, 19, 180
Replacing	169

E

Electronic telephone directory	72
How to use	73
Making voice calls	112
Transmitting document using	78
Enclosures	9
Erasing stored phone number	67
Error display message	146
Extender	9, 21, 22
Extension copy	130

F

Fax forwarding report	103
FAX mode	28, 50
Receiving documents in	50
Selecting the number of rings in	122
Feed pressure	154
FLASH button	12, 56, 115
Forwarding	101
Turning on or off from a remote location	104

H

HANDSET MUTE button	12, 117
HELP button	8, 12
HELP function	8
HYPHEN key	40

I

INSERT key	39
Installation	16
Connections	16

J

Journal report	124
Automatic printing	125
Manual printing	126

L

LCD contrast	136
Left cover	11
LEGAL PAPER SUPPLY button	14, 29
Legal-size paper	24, 51
Letter-size paper	22, 51
Logo	34
Position setting	123
Lower cover	11
Lower cover open button	11

M

Maintenance	160
Manual reception	48
Manual transmission	45, 47
Memory	7
Capacity	7
Reception	52
Transmission	93
MENU button	13
Message alert	140
MONITOR/VOICE STDBY button ...	12, 45, 54, 113
Multistation transmission	90
Multitransmission report	92

N

Network communication	96
Programming passcode	98
Reception passcode check	96, 100
Transmission passcode check	96, 99

O

On-hook dialing	54
One-touch dialing	75, 111
Making voice calls using	111
Storing phone numbers for	59, 61
Transmitting documents using	75
ORIGINAL button	13, 43
Overseas transmission mode	107

P

Paper	22, 182
Loading	22
Selecting paper size	29
Paper cassette	9, 22
Paper jam	155
Areas	155
Clearing	156, 158

Passcode	88, 96
Network passcode	96, 98
Polling passcode	88
Reception passcode check	96, 100
Transmission passcode check	96, 99
PAUSE button	12, 116
Polling	85
Being polled	86
Programming passcode	88
Power indicator	13
Power switch	11
Turning on	25
Power-down report	159
Printer cover	19
Printing	70, 125, 143
Journal report	126
Stored phone number list	71
System programming list	143

R

RECEIVE MODE button	13, 28
Receiving mode	8, 28
Selecting	28
Receiving reduction	132
Receiving tray	9, 21
Reception	48, 49
Automatic	49
Manual	48
REDIAL button	12, 46, 56
Redialing	46, 56
Reduction	128, 132
Copying	128
Reception	132
Repacking	172
Reserve phone	118
Resetting system programming features	141
RESOLUTION button	13, 43
Ring pattern detection	134
RINGER volume selector	11, 26

S

SECRET key	39
Storing	65
Secret phone number	65
SET button	13
Silent fax recognition ring	127
SPACE key	39
Specifications	181
Main unit	181
Paper	182

Speed dialing	77, 111
Making voice calls using	111
Storing phone numbers for	63
Transmitting documents using	77
Stand	11
START button	12, 45, 47
Station key cover	11
STOP/CLEAR button	12
System programming features	30
System programming list	143

T

TEL mode	8, 28
Receiving in	48
TEL/FAX delayed ring	137
TEL/FAX mode	8, 28
Receiving in	49
Selecting the number of rings in	127, 137
Telephone number list	70
TONE button	12, 115
Toner cartridge	17, 180
Preparing	17
Replacing	163
Transmission	42, 75
Delayed	81
Manual	45, 47
Memory	93
Multistation	90
Overseas	107
Report	120
Reserving	80
Using automatic dialer	75
Transmission speed	139
TRANSMIT SETTING button	13, 106
Troubleshooting	146

U

Upper cover	11
Upper cover open button	11

V

Voice calls	54, 111
Answering	56
Making	54
Using automatic dialer	111
Using handset	54
Using on-hook dialing	54
Voice contact	113
Initiating	113
Receiving a request for	114
VOLUME control button	12, 55

Others

◀ key	13, 39
▶ key	13, 39
▲ key	13, 73
▼ key	13, 73
* button	12, 115
# button	74

FCC Information

If required by the telephone company, inform them of the following.

- FCC Registration No.: (found on the rear of the unit)
- Ringer Equivalence: (found on the rear of the unit)
- The particular telephone line to which the unit is connected.

This unit must not be connected to a coin operated line. If you are on a party line, check with your local telephone company.

Ringer Equivalence Number (REN):

This REN is useful in determining the quantity of devices you may connect to your telephone line and still have all of those devices ring when your telephone number is called. In most but not all areas, the sum of the REN's of all devices connected to one line should not exceed five (5.0). To be certain of the number of devices you may connect to your line, as determined by the REN, you should contact your local telephone company to determine the maximum REN for your calling area.

In the event that terminal equipment causes harm to the telephone network, the telephone company should notify the customer, if possible, that service may be stopped. However, where prior notice is impractical, the company may temporarily cease service providing that they:

- a) Promptly notify the customer.
- b) Give the customer an opportunity to correct the problem with their equipment.
- c) Inform the customer of the right to bring a complaint to the Federal Communication Commission pursuant to procedures set out in FCC Rules and Regulations Subpart E of Part 68.

The Telephone Company may make changes in its communications facilities, equipment operations, or procedures where such action is reasonably required in the operation of its business and is not inconsistent with the rules and regulations in FCC Part 68. If such changes can be reasonably expected to render any customer terminal equipment incompatible with telephone company communications facilities, or require modification or alteration of such terminal equipment, or otherwise materially affect its use or performance, the customer shall be given adequate notice in writing, to allow the customer an opportunity to maintain uninterrupted service.

CAUTION:

To assure continued compliance with FCC rules, do not make any unauthorized modifications.

When programming emergency numbers and/or making test calls to emergency numbers:

1. Remain on the line and briefly explain to the dispatcher the reason for the call before hanging up.
2. Perform such activities in the off-peak hours; such as early morning or late evening.

This telephone provides magnetic coupling to hearing aids.

NOTE:

This equipment has been tested and found to comply with the limits for a Class A digital device, pursuant to Part 15 of the FCC Rules. These limits are designed to provide reasonable protection against harmful interference when the equipment is operated in a commercial environment. This equipment generates, uses, and can radiate radio frequency energy and, if not installed and used in accordance with the instruction manual, may cause harmful interference to radio communications. Operation of this equipment in a residential area is likely to cause harmful interference in which case the user will be required to correct the interference at his own expense.

Servicenter Directory

PRODUCT INFORMATION • OPERATION ASSISTANCE • LITERATURE REQUESTS • DEALER LOCATIONS

DIAL TOLL FREE: 1-800-HELP-FAX

Customer Service Center 2F-3, One Panasonic Way, Secaucus, NJ 07094 (Headquarters)
201-348-9090 (9:00am-8:00pm Monday-Friday, EST)

SERVICE INQUIRIES Regional Customer Care Department

NORTHEAST

2221 Cabot Boulevard West
Suite A
Langhorne, PA 19047
215-741-0676

Covers:

CT, DE, ME, MD, MA,
NH, NJ, NY, PA, RI, VT,
VA, DC, WV, Eastern OH

MIDWEST

1703 North Randall Road
Elgin, IL 60123
708-468-5530

Covers:

IL, IN, IA, KS, KY, MI,
MN, MO, NE, ND, SD,
WI, Western OH

WESTERN

6550 Katella Avenue
Cypress, CA 90630
714-373-7440

Covers:

AK, AZ, CA, CO, ID,
MT, NV, NM, OR, UT,
WA, WY, HI

SOUTHERN

1854 Shackelford Court
Suite 4105
Norcross, GA 30093
404-717-6860

Covers:

AL, AR, FL, GA, LA,
MS, NC, OK, SC, TN, TX

PRODUCT SERVICE Factory Servicenters

CALIFORNIA

6550 Katella Avenue
Cypress, CA 90630
714-373-7425

800 Dubuque Avenue
So. San Francisco,
CA 94080
415-871-6373

20201 Sherman Way
Suite 102
Canoga Park, CA 91306
818-709-1775

3878 Ruffin Road
Suite A
San Diego, CA 92123
619-560-9200

COLORADO

1640 South Abilene
Suite D
Aurora, CO 80012
303-752-2024

FLORIDA

3700 North 29th Avenue
Suite 102
Hollywood, FL 33020
305-925-2880

4710 Eisenhower Boulevard
Suite A1
Tampa, FL 33634
813-884-4746

GEORGIA

4245 International Boulevard
Suite C
Norcross, GA 30093
404-717-6880

HAWAII

99-859 Iwaiwa Street
Aiea, Hawaii 96701
808-488-1996

ILLINOIS

*1703 North Randall Road
Elgin, IL 60123
708-468-5466

*9401 W. Grand Avenue
Franklin Park, IL 60131
708-452-2580

9060 Golf Road
Niles, IL 60714
708-299-1700

MARYLAND

Sulphur Springs
Business Center
1638 Sulphur Springs Road
Baltimore, MD 21227
410-242-2607

MASSACHUSETTS

60 Glacier Drive, Suite G
Westwood, MA 02090
617-329-4280

MICHIGAN

37048 Van Dyke Avenue
Sterling Heights, MI 48312
313-939-2060

MINNESOTA

7850-12th Avenue South
Airport Business Center
Bloomington, MN 55425
612-854-8624

MISSOURI

11982 Dorsett Road
Maryland Heights,
MO 63043
314-739-5301

OHIO

1196 W. Kemper Road
Cincinnati, OH 45240
513-851-4180

PENNSYLVANIA

2221 Cabot Boulevard West
Suite B
Langhorne, PA 19047
215-741-0661

Campbell's Run
Business Center
500 Business Center Drive
Pittsburgh, PA 15205
412-788-2174

TENNESSEE

919-8th Avenue South
Nashville, TN 37203
615-244-4434

TEXAS

7420 Harwin Drive
Houston, TX 77036
713-781-1528

13615 Welch Road
Suite 101
Farmers Branch, TX 75244
214-385-1975

WASHINGTON

20425-84th Avenue South
Kent, WA 98032
206-872-7922

Service in Puerto Rico

PSC

San Gabriel Industrial Park
65th Infantry Avenue KM 9.5
Carolina, Puerto Rico 00630
809-750-5135

*pick-up/drop-off only

AUTHORIZED SERVICENTERS • PARTS DISTRIBUTOR LOCATIONS

To locate an independent authorized servicenter or parts distributor in your area, within the USA dial toll free 1-800-545-2672, 24 hours a day, 7 days a week.

ACCESSORY PURCHASES

1-800-332-5368 (Consumer Orders Only)

Matsushita Services Company Box 01, 545 Tollgate Road Suite C, Elgin, IL 60123
(8:00am-7:30pm Monday-Thursday; 8:00am-5:00pm Friday; 9:00am-12:30pm Saturday; CST)
(Visa, Mastercard, Discover card, Check or Money Order)

(9310)

6

Quasar Facsimile Limited Warranty

Quasar Company will repair this product with new or rebuilt parts, free of charge, in the U.S.A. or Puerto Rico for one (1) year from the date of original purchase in the event of a defect in materials or workmanship.

Carry-in or mail-in service in the U.S.A. can be obtained during the warranty period from a Matsushita Services Company (MSC) Factory Servicenter listed in the Servicenter Directory. Carry-in or mail-in service in Puerto Rico can be obtained during the warranty period by calling the telephone numbers listed in the Servicenter Directory.

This warranty is extended only to the original purchaser. A purchase receipt or other proof of date of original purchase will be required before warranty performance is rendered.

This warranty only covers failures due to defects in materials or workmanship which occur during normal use, and does not cover the supply cartridge and the drum unit. It does not cover damage which occurs in shipment or failures which are caused by products not supplied by Quasar Company or failures which result from accident, misuse, abuse, neglect, mishandling, misapplication, alteration, faulty installation, modification, or service by anyone other than an MSC Factory Servicenter or an authorized MSC Servicenter or damage that is attributable to Acts of God, including, but not limited to, line surges.

Limits and Exclusions

There are no express warranties except as listed above.

QUASAR COMPANY SHALL NOT BE LIABLE FOR SPECIAL, INCIDENTAL, CONSEQUENTIAL OR PUNITIVE DAMAGES, INCLUDING, WITHOUT LIMITATION, LOSS OF GOODWILL, PROFITS OR REVENUE, LOSS OF USE OF THIS PRODUCT OR ANY ASSOCIATED EQUIPMENT, COST OF SUBSTITUTE EQUIPMENT, DOWNTIME COSTS, OR CLAIMS OF ANY PARTY DEALING WITH BUYER FOR SUCH DAMAGES, RESULTING FROM THE USE OF THIS PRODUCT OR ARISING FROM BREACH OF WARRANTY OR CONTRACT, NEGLIGENCE, OR ANY OTHER LEGAL THEORY.

ALL EXPRESS AND IMPLIED WARRANTIES, INCLUDING THE WARRANTIES OF MERCHANTABILITY AND FITNESS FOR A PARTICULAR PURPOSE, ARE LIMITED TO THE APPLICABLE WARRANTY PERIOD SET FORTH ABOVE.

Some states do not allow the exclusion or limitation of consequential damages, or limitations on how long an implied warranty lasts, so the above exclusions or limitations may not apply to you.

This warranty gives you specific legal rights, and you may also have other rights which vary from state to state.

If a problem with this facsimile develops during the warranty period, you may contact your dealer or the MSC Factory Servicenter or authorized Quasar Service Dealer. If the problem is not handled to your satisfaction, write to the Quasar Company Consumer Affairs Division at the address indicated on the Servicenter Directory.

Quasar Company

1707 North Randall Road Elgin, Illinois 60123
Division of Matsushita Electric Corporation of America

Printed in Japan

PQQX10866ZA S0294M1034